

Chapter 3

Material Properties

Scope

A principal objective of the following brief review of the nature of polyethylene (PE) piping materials, of their physical and chemical properties, and of their mechanical and engineering behavior, is to impart a basic understanding of the factors that lie behind the discussions and recommendations contained in this Handbook for the proper storage, handling, installation, design and operation of PE piping systems.

Also included in this Chapter is an Appendix that lists values for the more common engineering design properties of PE piping materials.

Introduction

A number of important performance advantages accounts for the widespread adoption of PE piping for so many pressure and non-pressure applications. A major one is PE's virtual freedom from attack by soils, and by ambient water and moisture. PE, being a non-conductor of electricity, is immune to the electrochemical based corrosion process that is induced by electrolytes such as salts, acids and bases. In addition, PE piping is not vulnerable to biological attack, and its smooth, non-stick inner surface results in low friction factors and exceptional resistance to fouling.

Another unique performance advantage is the flexibility of PE pipe. It allows for changes in direction with minimal use of fittings, facilitates installation, and makes it possible for piping up to about 6-inches in diameter to be offered in coils of longer lengths. A further one is strainability, a term denoting a capacity for high deformation without fracture. In response to earth loading a buried PE pipe can safely deflect and thereby gain additional and substantial support from the surrounding soil. So much so, that a properly installed PE pipe is capable of supporting earth fills and surface live loads that would fracture pipes that, although much stronger, can crack and fail at low strains. And, as proven by actual experience, PE pipe's high strainability makes it very resistive to seismic effects.

PE pipe and PE fittings can be joined to each other by thermal fusion processes which result in leak-proof bottle-tight joints that are as strong and as tough as the pipe itself. These advantages combine to make PE a preferred pipe for special applications, such as for horizontal directional drilling, for the renewal of old pipes by insertion, and for marine outfalls. For the first two named applications the butt-fusion process – which avoids the use of larger diameter couplings – enables installation to be conducted by pipe pulling and it permits the use of a larger diameter pipe.

Another recognized advantage of PE piping is its toughness. PE pipes, as well as the heat fusion joints in PE piping, greatly resist the propagation of an initial small failure into a large crack – a major reason for the overwhelming preference for PE piping for gas distribution applications. And, PE piping retains its toughness even at lower temperatures. In addition, PE piping exhibits very high fatigue resistance. Potential damage by repetitive variations in operating pressure (surges) is highly resisted.

Notwithstanding the above and various other advantages of PE piping, its successful design and application requires adequate recognition of its more complex stress/strain and stress/fracture behavior. PE piping does not exhibit the simple proportionality between stress and strain that is characteristic of metal pipes. And, its capacity to resist fracture is reduced as duration of loading is increased. In addition, these and its other mechanical properties exhibit a greater sensitivity to temperature and certain environments. Furthermore, the specific mechanical responses by a PE pipe can vary somewhat depending on the PE material from which it is made – mostly, depending on the nature of the PE polymer (e.g., its molecular weight, molecular weight distribution, degree of branching (density) but, also somewhat on the type and quantity of additives that are included in the piping composition. The particular behavior of the PE pipe that is selected for an application must be given adequate recognition for achieving an effective design and optimum quality of service. A brief explanation of the engineering behavior of PE and the listing of its more important properties is a major objective of this Chapter.

An additional objective of this Chapter is the presentation of values for the major properties that are used for material classification and piping design, and a brief description of the methods based on which these properties are determined.

PE Plastics

Plastics are solid materials that contain one or more polymeric substances which can be shaped by flow. Polymers, the basic ingredient of plastics, compose a broad class of materials that include natural and synthetic polymers. Nearly all plastics are made from the latter. In commercial practice, polymers are frequently designated as resins. For example, a PE pipe compound consists of PE resin combined with colorants, stabilizers, anti-oxidants or other ingredients required to protect and enhance properties during fabrication and service.

Plastics are divided into two basic groups, thermoplastics and thermosets, both of which are used to produce plastic pipe.

Thermoplastics include compositions of PE, polypropylene, and polyvinyl chloride (PVC). These can be re-melted upon the application of heat. The solid state of thermoplastics is the result of physical forces that immobilize polymer chains and prevent them from slipping past each other. When heat is applied, these forces weaken and allow the material to soften or melt. Upon cooling, the molecular chains stop slipping and are held firmly against each other in the solid state. Thermoplastics can be shaped during the molten phase of the resin and therefore can be extruded or molded into a variety of shapes, such as pipe, pipe fittings, flanges or valves.

Thermoset plastics are similar to thermoplastics prior to “curing,” a chemical reaction by which polymer chains are chemically bonded to each other by new cross-links. The curing is usually done during or right after the shaping of the final product. Cross-linking is the random bonding of molecules to each other to form a giant three-dimensional network. Thermoset resins form a permanent insoluble and infusible shape after the application of heat or a curing agent. They cannot be re-melted after they have been shaped and cured. This is the main difference between thermosets and thermoplastics. As heat is applied to a thermoset part, degradation occurs at a temperature lower than the melting point. The properties of thermosetting resins make it possible to combine these materials with reinforcements to form strong composites. Fiberglass is the most popular reinforcement, and fiberglass-reinforced pipe (FRP) is the most common form of thermoset-type pipe.

History of PE

The Imperial Chemical Company (ICI) in England first invented PE in 1933. The early polymerization processes used high-pressure (14,000 to 44,000 psi) autoclave reactors and temperatures of 200° to 600° F (93° to 316° C). The PE that came from these reactors was called “high pressure PE.” It was produced in a free radical chain reaction by combining ethylene gas under high pressure with peroxide or a trace amount of oxygen.

The original process was dangerous and expensive, so other safer and less expensive processes were developed. PE produced at low pressure was introduced in the 1950’s. These methods also afforded greater versatility in tailoring molecular structures through variations in catalysts, temperatures, and pressures.

Manufacture of PE

Polymers are large molecules formed by the polymerization (i.e. the chemical linking) of repeating small molecular units. To produce PE, the starting unit is ethylene, a colorless gas composed of two double-bonded carbon atoms and four hydrogen atoms (see Figure 1).

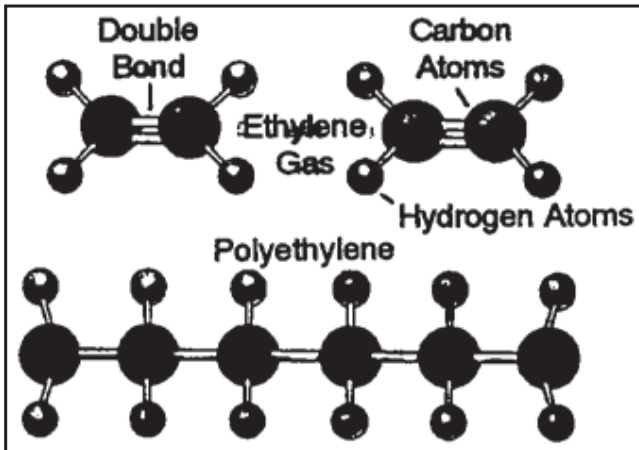

Figure 1 Manufacture of PE

There are currently three primary low-pressure methods for producing PE: gas-phase, solution and slurry (liquid phase). The polymerization of ethylene may take place with various types of catalysts, under varying conditions of pressure and temperature and in reactor systems of radically different design. Ethylene can also be copolymerized with small amounts of other monomers such as butene, propylene, hexene, and octene. This type of copolymerization results in small modifications in

chemical structure, which are reflected in certain differences in properties, such as density, ductility, hardness, etc. Resins that are produced without comonomer are called homopolymers.

Regardless of process type, the chemical process is the same. Under reaction conditions, the double bond between the carbon atoms is broken, allowing a bond to form with another carbon atom as shown in Figure 1. Thus, a single chain of PE is formed. This process is repeated until the reaction is terminated and the chain length is fixed. PE is made by the linking of thousands of monomeric units of ethylene.

Polymer Characteristics

PE resins can be described by three basic characteristics that greatly influence the processing and end-use properties: density, molecular weight and molecular weight distribution. The physical properties and processing characteristics of any PE resin require an understanding of the roles played by these three major parameters.

Density

The earliest production of PE was done using the high-pressure process which resulted in a product that contained considerable “side branching.” Side branching is the random bonding of short polymer chains to the main polymer chain. Since branched chains are unable to pack together very tightly, the resulting material had a relatively low density, which led to it being named low-density PE (LDPE).

As time passed and PEs of different degrees of branching were produced, there was a need for an industry standard that would classify the resin according to density. The American Society for Testing of Materials (ASTM) originally established the following classification system. It is a part of ASTM D1248, Standard Specification for Polyethylene Plastics Molding and Extrusion Materials^(2,5). This standard has since been replaced by ASTM D 3350; ASTM D 1248 is no longer applicable to PE piping materials.

Type	Density
I	0.910 - 0.925 (low)
II	0.926 - 0.940 (medium)
III	0.941 - 0.959 (high)
IV	0.960 and above (high, homopolymer)

Type I is a low-density resin produced mainly in high-pressure processes. Also contained within this range are the linear-low-density polyethylenes (LLDPE), which represent a recent development in the PE area using low-pressure processes.

Type II is a medium density resin produced either by low- or high-pressure processes.

Types III and IV are high-density polyethylenes. Type III materials are usually produced with a small amount of a comonomer (typically butene or hexene) that is used to control chain branching. Controlled branching results in improved performance in applications where certain types of stresses are involved. Type IV resins are referred to as homopolymers since only ethylene is used in the polymerization process, which results in least-branched and highest-possible-density material. Figure 2 depicts the various molecular structures associated with each type of PE.

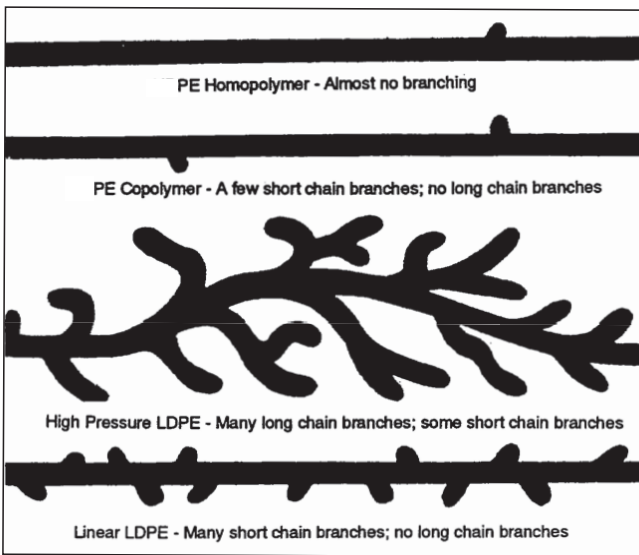

Figure 2 Chain Structure of PE

Crystallinity

The amount of side branching determines the density of the PE molecule. The more side branches, the lower the density. The packing phenomenon that occurs in PE can also be explained in terms of crystalline versus non-crystalline or amorphous regions as illustrated in Figure 3. When molecules pack together in tight formation, the intermolecular spacing is reduced.

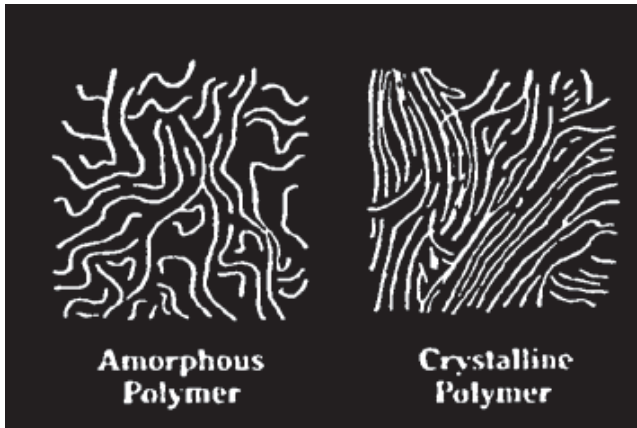
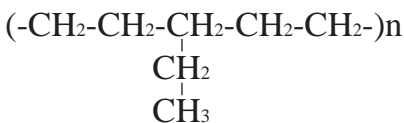

Figure 3 Crystallinity in PE

PE is one of a number of polymers in which portions of the polymer chain in certain regions align themselves in closely packed and very well ordered arrangements of polyhedral-shaped, microscopic crystals called spherulites. Other portions of the polymer chain lie in amorphous regions having no definite molecular arrangement. Since polyethylene contains both crystalline and amorphous regions, it is called a semicrystalline material. Certain grades of high density PE can consist of up to 90% crystalline regions compared to 40% for low density PE. Because of their closer packing, crystalline regions are denser than amorphous regions. Polymer density, therefore, reflects the degree of crystallinity.

As chain branches are added to a PE backbone through co-polymerization, the site and frequency of chain branches affect other aspects of the crystalline/ amorphous network. This includes the site and distribution of spherulites, as well as the nature of the intermediate network of molecules that are between spherulites. For example, using butene as co-monomer results in the following “ethyl” side chain structure⁽⁸⁾:



or using hexene results in this “butyl” side chain:

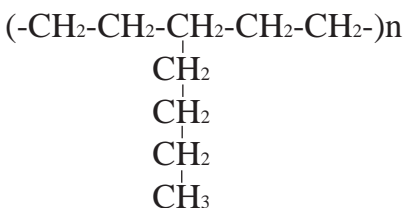

If two polymers were produced, one using butyl and the other hexene monomer, the polymer that contained the resultant butyl branches would have a lower density. Longer side branching reduces crystallinity and therefore lowers density. For high-density PE, the number of short chain branches is on the order of 3 to 4 side chains per 1,000 carbon atoms. It only takes a small amount of branching to affect the density.

Resin density influences a number of physical properties. Characteristics such as tensile yield strength and stiffness (flexural or tensile modulus) are increased as density is increased.

Molecular Weight

The size of a polymer molecule is represented by its molecular weight, which is the total of the atomic weights of all the atoms that make up the molecule. Molecular weight exerts a great influence on the processability and the final physical and mechanical properties of the polymer.

Molecular weight is controlled during the manufacturing process. The amount of length variation is usually determined by catalyst, conditions of polymerization, and type of process used. During the production of polyethylene, not all molecules grow to the same length. Since the polymer contains molecules of different lengths, the molecular weight is usually expressed as an average value.

There are various ways to express average molecular weight, but the most common is the number average (M_n) and weight average (M_w). The definitions of these terms are as follows:

$M_n = \text{Total weight of all molecules} \div \text{Total number of molecules}$

**$M_w = (\text{Total weight of each size}) (\text{respective weights}) \div$
Total weight of all molecules**

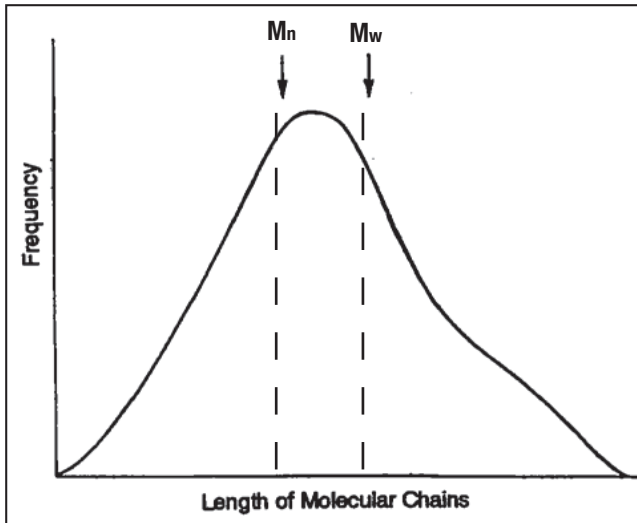

Figure 4 Typical Molecular Weight Distribution

Figure 4 illustrates the significance of these terms and includes other less frequently used terms for describing molecular weight.

Molecular weight is the main factor that determines the durability-related properties of a polymer. Long-term strength, toughness, ductility, and fatigue-endurance improve as the molecular weight increases. The current grades of highly durable materials result from the high molecular weight of the polymer.

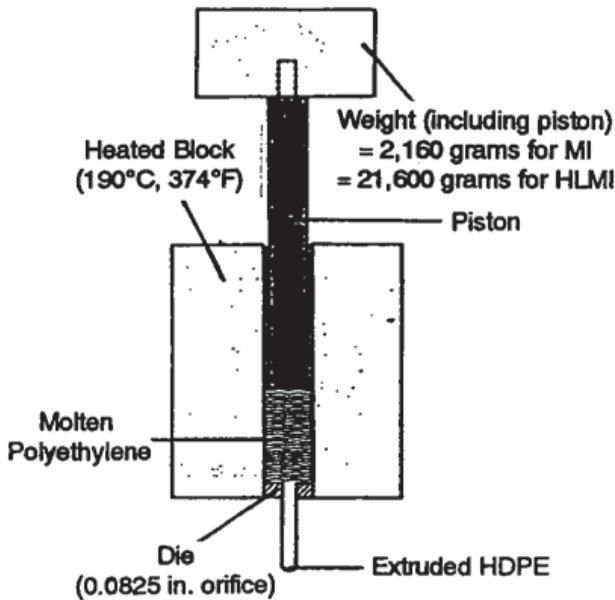

Figure 5 The Melt Flow Test (per ASTM D1238)

Molecular weight affects a polymer's melt viscosity or its ability to flow in the molten state. The standard method used to determine this "flowability" is the melt flow rate apparatus, which is shown in Figure 5. ASTM D1238, *Standard Test Method for Flow Rates of Thermoplastics by Extrusion Plastometer*⁽²⁾, is the industry standard for measuring the melt flow rate. The test apparatus measures the amount of material that passes through a certain size orifice in a given period of time when extruded at a predetermined temperature and under a specified weight. The melt flow rate is the measured weight of material that passes through the orifice in ten minutes.

The standard nomenclature for melt flow rate, as described in ASTM D1238, lists the test temperature and weight used. A typical designation is condition 190/2.16 that indicates the test was conducted at a temperature of 190°C while using a 2.16-kg weight on top of the piston. Other common weights include: 5 kg, 10 kg, 15 kg and 21.6 kg.

The term "melt index"(MI) is the melt flow rate when measured under a particular set of standard conditions – 190°C/2.16 kg. This term is commonly used throughout the polyethylene industry.

Melt flow rate is a rough guide to the molecular weight and processability of the polymer. This number is inversely related to molecular weight. Resins that have a low molecular weight flow through the orifice easily and are said to have a high melt flow rate. Longer chain length resins resist flow and have a low melt flow rate. The

melt flow rates of these very viscous (stiff) resins are very difficult to measure under the common conditions specified by this test. Therefore, another procedure is used where the weight is increased to 21.6 kg from the 2.16 kg weight used in the normal test procedure. This measurement is commonly referred to as the High Load Melt Index (HLMI) or 10X scale. There are other melt flow rate scales that use 5 kg, 10 kg or 15 kg weights.

There are various elaborate analytical techniques for determining molecular weight of a polymer. The melt flow rate gives a very quick, simple indication of the molecular weight. The more sophisticated methods include Gel Permeation Chromatography (GPC). The essence of GPC is to dissolve the polymer in a solvent and then inject the solution into a column (tubing). The column contains a porous packing material that retards the movements of the various polymer chains as they flow through the column under pressure. The time for the polymer to pass through the column depends upon the length of the particular polymer chain. Shorter chains take the longest time due to a greater number of possible pathways. Longer chain molecules will pass more quickly since they are retained in fewer pores. This method measures the distribution of the lengths of polymer chains along with the average molecular weight.

Effect of Molecular Weight Distribution on Properties

The distribution of different sized molecules in a polyethylene polymer typically follows the bell shaped normal distribution curve described by Gaussian probability theory. As with other populations, the bell shaped curve can reflect distributions ranging from narrow to broad. A polymer with a narrow molecular weight distribution (MWD) contains molecules that are nearly the same in molecular weight. It will crystallize at a faster, more uniform rate. This results in a part that will have less warpage.

A polymer that contains a broader range of chain lengths, from *short* to *long* is said to have a broad MWD. Resins with this type of distribution have good slow crack growth (SCG) resistance, good impact resistance and good processability.

Polymers can also have a bimodal shaped distribution curve which, as the name suggests, seem to depict a blend of two different polymer populations, each with its particular average and distribution. Resins having a bimodal MWD contain both very short and very long polyethylene molecules, giving the resin excellent physical properties while maintaining good processability. Figure 6 shows the difference in these various distributions.

The latest generation of high density PE pipe materials, known as high performance materials (e.g. PE 4710), are, for the most part, produced from bimodal resins. Pipe made from these materials are characterized by truly exceptional and unique resistance to slow crack growth (SCG), significantly improved long term performance, higher pressure ratings or increased flow capacity, and improved chemical resistance, all of which are achieved without compromising any of the other traditional benefits that are associated with the use of PE pipe.

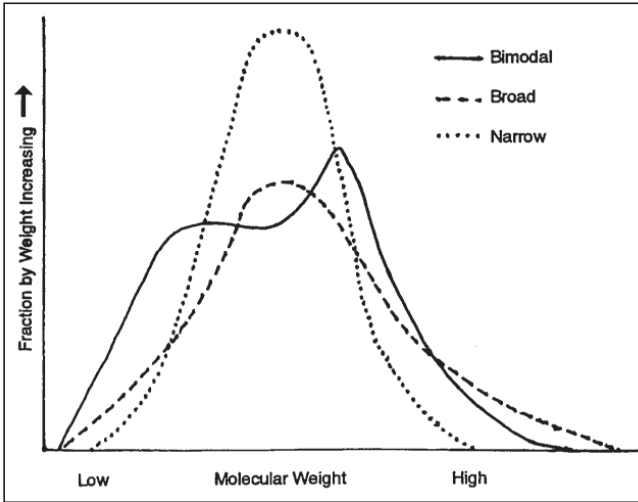

Figure 6 Molecular Weight Distribution

MWD is very dependent upon the type of process used to manufacture the particular polyethylene resin. For polymers of the same density and average molecular weight, their melt flow rates are relatively independent of MWD. Therefore, resins that have the same density and MI can have very different molecular weight distributions. The effects of density, molecular weight, and molecular weight distribution on physical properties are summarized in Table 1.

TABLE 1
Effects of Changes in Density, Melt Index, and Molecular Weight Distribution

Property	As Density Increases, Property	As Melt Index Increases, Property	As Molecular Wt. Distribution Broadens, Property
Tensile Strength (@ Yield)	Increases	Decreases	—
Stiffness	Increases	Decreases Slightly	Decreases Slightly
Impact Strength	Decreases	Decreases	Decreases
Low Temperature Brittleness	Increases	Increases	Decreases
Abrasion Resistance	Increases	Decreases	—
Hardness	Increases	Decreases Slightly	—
Softening Point	Increases	—	Increases
Stress Crack Resistance	Decreases	Decreases	Increases
Permeability	Decreases	Increases Slightly	—
Chemical Resistance	Increases	Decreases	—
Melt Strength	—	Decreases	Increases
Gloss	Increases	Increases	Decreases
Haze	Decreases	Decreases	—
Shrinkage	Increases	Decreases	Increases

PE Piping Materials

The Nature of PE Piping Materials

A PE piping material consists of a polyethylene polymer (commonly designated as the resin) to which has been added small quantities of colorants, stabilizers, anti-oxidants and other ingredients that enhance the properties of the material and that protect it during the manufacturing process, storage and service. PE piping materials are classified as thermoplastics because they soften and melt when sufficiently heated and harden when cooled, a process that is totally reversible and may be repeated. In contrast, thermosetting plastics become permanently hard when heat is applied.

Because PE is a thermoplastic, PE pipe and fittings can be fabricated by the simultaneous application of heat and pressure. And, in the field PE piping can be joined by means of thermal fusion processes by which matching surfaces are permanently fused when they are brought together at a temperature above their melting point.

PE is also classified as a semi-crystalline polymer. Such polymers (e.g., nylon, polypropylene, polytetrafluoroethylene), in contrast to those that are essentially amorphous (e.g., polystyrene, polyvinylchloride), have a sufficiently ordered structure so that substantial portions of their molecular chains are able to align closely to portions of adjoining molecular chains. In these regions of close molecular alignment crystallites are formed which are held together by secondary bonds. Outside these regions, the molecular alignment is much more random resulting in a

less orderly state, labeled as amorphous. In essence, semi-crystalline polymers are a blend of a two phases, crystalline and amorphous, in which the crystalline phase is substantial in population.

A beneficial consequence of PE's semi-crystalline nature is a very low glass transition temperature (T_g), the temperature below which a polymer behaves somewhat like a rigid glass and above which it behaves more like a rubbery solid. A significantly lower T_g endows a polymer with a greater capacity for toughness as exhibited by performance properties such as: a capacity to undergo larger deformations before experiencing irreversible structural damage; a large capacity for safely absorbing impact forces; and a high resistance to failure by shattering or rapid crack propagation. These performance aspects are discussed elsewhere in this Chapter. The T_g for PE piping materials is approximately -130°F (-90°C) compared to approximately 221°F (105°C) for polyvinyl chloride and 212°F (100°C) for polystyrene, both of which are examples of amorphous polymers that include little or no crystalline content.

In the case of amorphous polymers, their melting temperature, the temperature at which a transition occurs between the rubbery solid and the liquid states, is not much higher than their T_g . Also for amorphous polymers, the transition between a rubbery solid and a viscous liquid is not very emphatic. This contrasts with semi-crystalline polymers, for which this transition corresponds with the melting of all crystallites, and above which a highly viscous liquid state is reached. This more emphatic transition in PE between the semi-crystalline solid and highly viscous liquid states facilitates manufacture, fabrication and field joining because it allows for more efficient 'welding' to be conducted – when in a liquid state the polymer molecules are able to more effectively diffuse into each other and thereby, form a monolithic structure. In contrast, the melting point of amorphous polymers is less defined and, across this melting point there is not as definite a transition between a rubbery, or plastic state, and a liquid viscous state.

Structural Properties

PE Pipe Material Designation Code Identifies the Standard Classification of Essential Properties

Standards for PE piping define acceptable materials in accordance with a standard designation code. This code, which is explained in greater detail in Chapter 5, has been designed for the quick identification of the pipe material's principal structural and design properties. As this section deals with this subject, it is appropriate to first describe the link between the code designations and these principal properties. For this purpose, and as an example, the significance of one designation, PE4710, is next explained.

- The letters PE designate that it is a polyethylene piping material.
- The first digit, in this example the number 4, identifies the PE resin's density classification in accordance with ASTM D3350, Standard Specification for Polyethylene Plastic Pipe and Fittings Materials ⁽⁴⁾.

Certain properties, including stress/strain response, are dependent on a PE's crystalline content. An increase in this phase is reflected by an increase in density. An increase in density affects certain properties, for example an increase in tensile strength and stiffness. Also, a higher density results in changes to other properties. For this reason, the Table for Apparent Modulus that is included in the Appendix of this chapter lists values in accordance with the material's standard density classification. This ASTM standard classification can range from 2, the lowest value, to 4 the highest value.

- The second digit, in this example the number 7, identifies the material's standard classification for slow crack growth resistance – also, in accordance with ASTM D3350 – relating its capacity for resisting the initiation and propagation of slowly growing cracks when subjected to a sustained localized stress intensification.

The standard classification for current commercial grades is either 6 or 7. The 6 denotes very high resistance and the 7 even higher. The test method for determining quality of resistance to SCG is described later in this chapter.

- The third and fourth digits combined, the number 10 in this example, denote the material's recommended hydrostatic design stress (HDS) for water at 73°F (23°C), in units of 100psi. In this example the number 10 designates the HDS is 1,000psi. There are two basic performance criteria based on which a recommended HDS is determined. The first is the material's long term hydrostatic strength (LTHS), a value that is required to comply with certain additional validation or substantiation requirements that are discussed later in this Chapter. The second is the material's quality of resistance to the initiation and growth of slowly growing cracks. An explanation of both of these criteria is included in this section. And, the standard method by which an LTHS is reduced into an HDS is explained in Chapter 5, "Standard Specifications, Test Methods and Codes for PE Piping Systems".

Stress/Strain Response and its Representation by Means of an Apparent Modulus

The potential range of the stress/strain response of a material is bounded by two extremes. At one extreme the response can be perfectly elastic; that is, in conformity to Hook's law whereby the magnitude of strain is always proportional to the magnitude of the applied stress. The resultant proportionality between stress and strain is labeled the modulus of elasticity. Elastic deformation is instantaneous, which means that total deformation (or strain) occurs at the instant the stress is applied. Upon the release of the external stress the deformation is instantaneously and totally

recovered. This behavior is represented in Figure 7b as strain versus time for the instantaneous load-time curve depicted in Figure 7a. Under the modulus of elasticity concept, the stress/strain relationship is independent of duration of load application.

At the other extreme, under what is referred to as viscous behavior, deformation caused by the application of a stress is neither instantaneous nor proportional to the stress. Deformation is delayed and the rate and the final extent of deformation are dependent on the magnitude and the duration of the applied stress. Also, the deformation that occurs is not reversible after the stress is released. This response is depicted by Figure 7c.

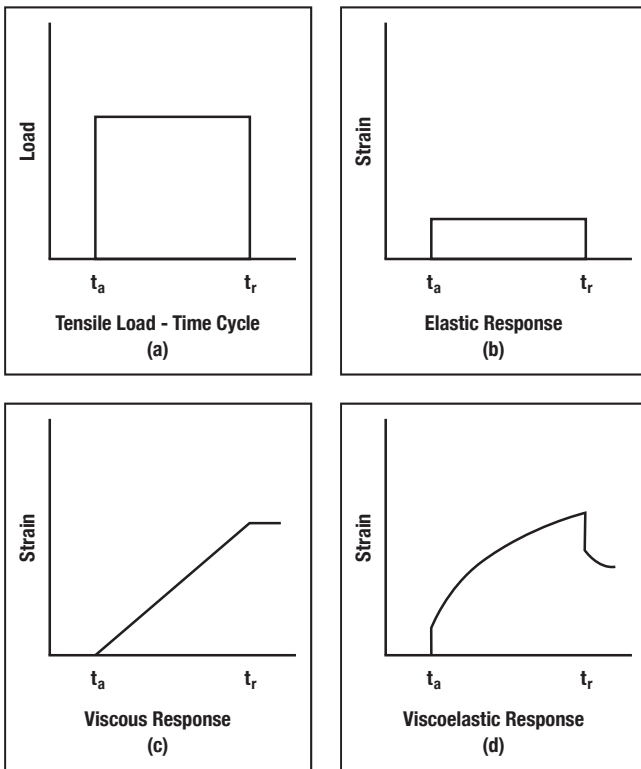

Figure 7 Strain Response (b-d) to a Load (a)

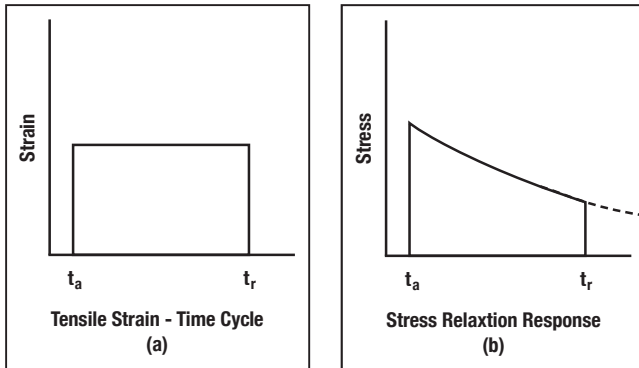

Figure 8 Stress Relaxation Response by a Viscoelastic Material

Viscoelastic behavior, which is depicted by Figure 7d, covers the intermediate region between these extremes. The imposition of a stress in the manner of Figure 7a results in a small instantaneous elastic strain that is then followed by a time-dependent strain. Upon removal of the stress there is a small elastic recovery of strain that is then followed by a time-dependent recovery. This time dependent recovery occurs more quickly for lower values of initial strain and more slowly for an initially larger strain. While the strain recovery may eventually be nearly total, there is almost always some remaining permanent deformation, which, again, is larger for an initially larger deformation.

Figure 7d illustrates viscoelastic response under the condition of constant tensile stress. However, if a strain is imposed and then kept constant, the initially required stress gradually decreases in the course of time. This reaction, which is illustrated by Figure 8, is called stress-relaxation. Stress relaxation is a beneficial response in situations where further deformation is either restrained or counteracted.

Models based on springs – which represent elastic response – and on dashpots –representing viscous response – have been developed to illustrate and to simulate the viscoelastic behavior of PE piping materials.^(11 12) A simple one, known as the Maxwell model⁽²⁹⁾, is shown on the right side of Figure 9. In this model the lone spring represent the elastic reaction, the parallel arrangement of spring and dashpot represents the viscoelastic reaction and, the dashpot represents the viscous reaction.

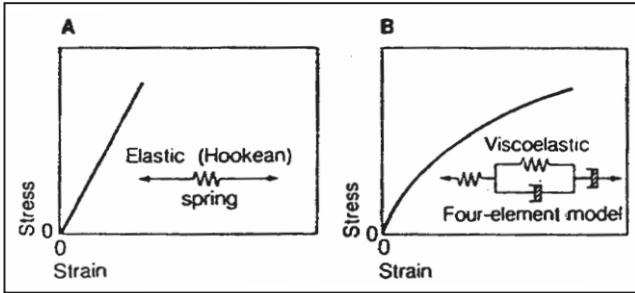

Figure 9 The Maxwell Model

A resultant stress/strain relationship for a viscoelastic/thermoplastic material is determined by a number of variables, principally the following:

1. The magnitude of the initial stress or strain (a larger stress or strain results in a larger viscous response)
2. The multi-axiality of the resultant stress (when a material is simultaneously pulled in more than one direction this inhibits its freedom to deform)
3. The duration of the sustained stress or of the sustained strain (increased duration results in a larger total response)
4. The temperature (it mostly affects the rate of the viscous response)
5. The environment (if an organic substance is adsorbed to some extent by PE, this may result in a plasticizing effect that mostly accelerates the viscous response – air and water are inert in this respect and they produce equivalent results)
6. Possible external restraints on the freedom to deform (e.g., the embedment around a buried pipe restricts free-creeping)

A frequently used method for evaluating the stress/strain response of PE piping materials is by means of tensile/creep tests that are conducted on test bars. In these tests, the specimens are subjected to a uni-axial stress and they are allowed to free-creep, meaning that their deformation is unrestrained. This combination of test parameters yields the maximum possible deformation under a certain sustained stress. When the logarithm of the strain (deformation) resulting from such tests is plotted against the logarithm of duration of loading it yields an essentially straight line for each level of sustained test stress. This behavior is illustrated by Figure 10. This essentially straight line behavior facilitates extrapolation of experimental results to longer durations of loading than covered by the data (the extrapolation is denoted by the dotted lines in Figure 10).

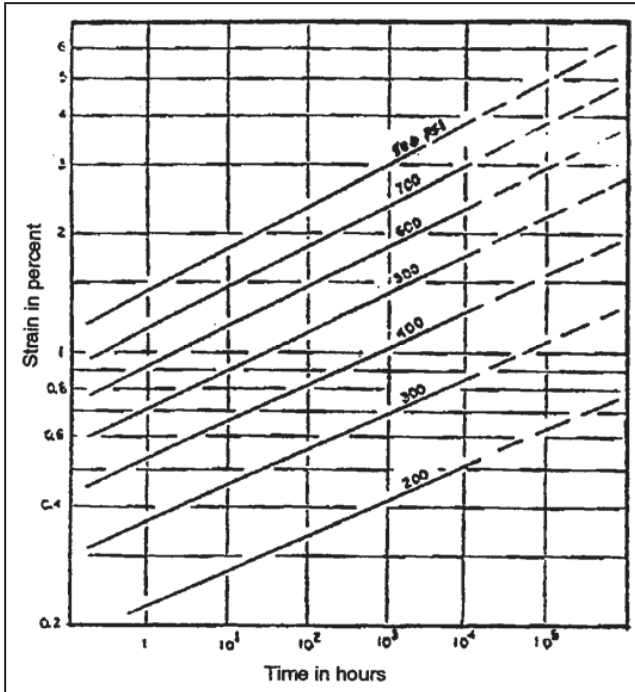

Figure 10 Typical Tensile Stress /Creep Response for a PE3XXX Piping Material When Subjected to a Sustained Uni-axial Tensile Stress, in Air at 73°F

Any point on a tensile/creep diagram, such as in Figure 10 gives a stress/strain ratio. To differentiate this ratio from the modulus of elasticity, which only applies to elastic behaving materials, it is designated as the apparent modulus under tension. For correct engineering use, a value of apparent modulus must identify the conditions under which that value has been established: the kind of stress (uni-axial versus bi- or multi-axial); the magnitude of the principal stress; the duration of stress application; the temperature; and, the test environment. Figure 11 illustrates the manner by which the apparent modulus of a PE3XXX material varies, at 73°F and in air, after different durations of sustained loading and in response to uni-axial stresses of different intensities.

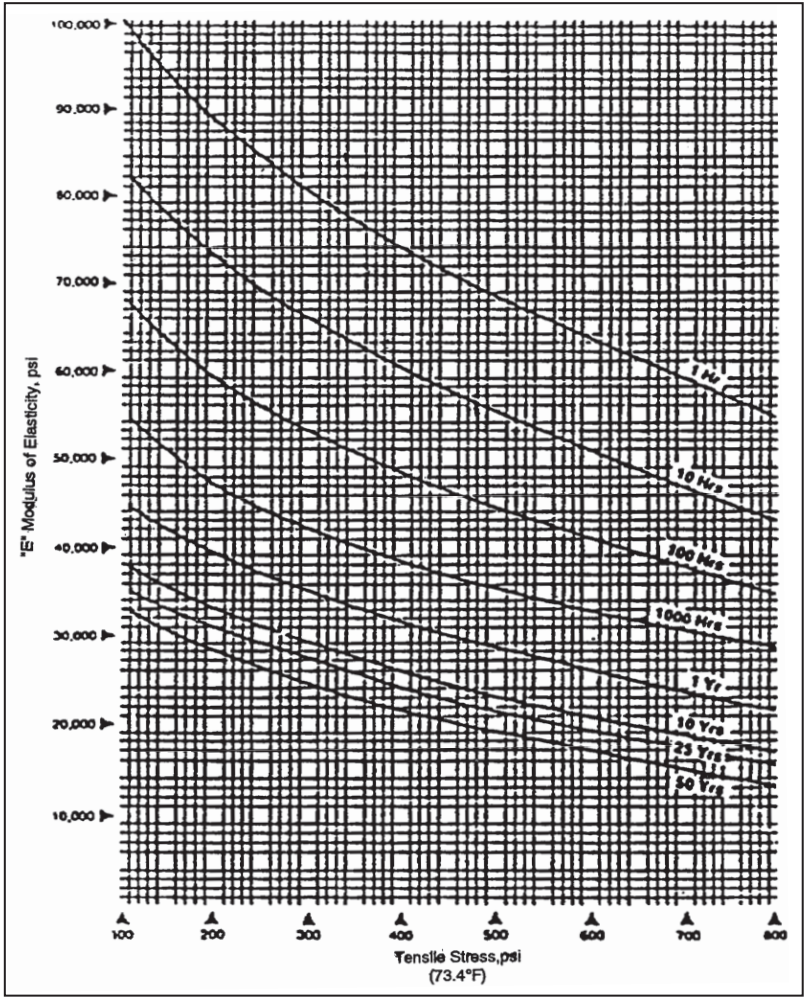

Figure 11 Apparent Modulus Versus Stress-Intensity for PE3XXX* Material when Evaluated Under Uni-Axial Stressing, In Air and at 73°F

* The PE3XXX designation covers all pipe materials that are made using a PE resin that meets the requirements for the Class 3 density classification, in accordance with ASTM D3350.

Apparent moduli have also been evaluated on pressurized pipe specimens by measuring the increase in pipe diameter as a function of pressure (stress) and time under pressure. In these tests the pipe specimen is subjected to bi-axial stressing – a circumferential stress and an axial stress that is about one-half of the magnitude of the circumferential stress. This combination of stresses works to restrain deformation. The result is an apparent modulus that is about 25% larger than that determined under uni-axial tension.

Analogous apparent moduli can also be derived from stress-relaxation data. However, the numerical difference between an apparent modulus derived from tensile creep data and one derived from stress relaxation data is generally small for typical working stresses and when the times under a continuous load, or strain, are matched. Accordingly, the two can be used interchangeably for common engineering design.

Apparent Modulus Under Compressive Stress

Apparent moduli can also be derived for the condition of compressive stress. Such a value tends to be somewhat larger because the resultant deformation causes a slight increase in the area that resists the applied stress. However, the resultant increase is generally small, allowing the tensile stress value to adequately and conservatively represent the compression state.

In summary

The apparent modulus concept has proven to be very useful and effective. Even though PE piping materials exhibit viscoelastic behavior, this concept allows for piping design to be conducted by means of the same equations that have been developed based on the assumption of elastic behavior. However, it is important to recognize that a value of an apparent modulus that is used for a design must adequately reflect the viscoelastic response that is expected to occur under the anticipated service conditions. In this regard it should be noted, as illustrated by Figure 11, that a value of apparent modulus is dependent not only on duration of loading but also, on stress intensity. However, in nearly all PE pipe applications the maximum stresses that are generated by reactions other than that which is caused by internal pressure – a reaction that, as shown by the section that follows, is treated as a separate design issue – are of a magnitude that seldom exceeds the range of about 300 to 400psi. Accordingly, the apparent modulus values within this stress range may be accepted as an appropriate and conservative value for general design purposes. This is the major consideration behind the design values that are presented in Table B.1.1 in the Appendix to this Chapter. It should also be recognized that the values in this table apply to the condition of uni-axial stressing. Thus, these values tend to be conservative because in most applications there exists some multi-axiality of stressing, a condition that leads to a somewhat larger apparent modulus.

There is one kind of operation that results in a temporary tensile stress that is significantly beyond the maximum range of 300-400psi for which Table B.1.1 applies. This is an installation by pipe pulling, a procedure that is the subject of Chapter 12. At the significantly greater uni-axial stresses that result under this installation procedure, the resultant apparent modulus is about 2/3rds of the values that are listed in Table B.1.1.

An aspect of Table B.1.1 worth noting is that it presents values in accordance with the standard density classification of the PE resin (the first numeral after the PE designation), in accordance with ASTM D3350 (Refer to Chapter 5 for a detailed explanation of the D3350 classification system). As discussed earlier in this Chapter, a higher resin density reflects a higher crystalline content. And, the higher the content, the greater a material's apparent modulus.

As mentioned earlier, the apparent modulus varies with temperature. Table B.1.2 in the Appendix to this Chapter lists multipliers for the converting of the apparent modulus for the base temperature of 73°F to another temperature of design interest.

Stress/Fracture Behavior and the Determination of Working Strength

Introduction

Successful design requires that the working strength of a material be defined in relation to the various conditions under which it is intended to be used and in recognition of its structural behavior. The working tensile strength of PE is affected by essentially the same variables that affect its stress/strain relationship, principally magnitude of load, duration of loading, temperature and environment. However, there is one important difference. Whereas strain response is in reaction to the nominal value (the so called bulk or, average value) of applied stress, fracture can result from either the effect of a nominal stress, or from that of a local intensified stress. Under an excessively large nominal stress PE continues to slowly deform until a sufficiently large deformation is reached at which the material begins to yield. Yielding is then quickly followed by structural failure. This failure mechanism, because it is preceded by yielding or plastic deformation, occurs in what is referred to as the ductile state.

In contrast, a locally intensified stress can sometimes lead to the initiation and subsequent propagation of a localized and very slowly growing crack. When the crack grows to a size that spans from the inside to the outside wall of a pressure pipe a leak is the end result. Even though a failure in PE pipe which results from slow crack growth (SCG) is greatly resistant of its propagation into a larger crack – a very beneficial feature of PE pipe – it is identified as brittle-like because it occurs absent of any localized yielding or plastic deformation. Such absence is symptomatic of the fracture process that occurs in what is known as the brittle state. The working strength of each commercial grade of PE pipe material is determined in consideration of both of these possible failure mechanisms.

In a pressure pipe application the major nominal stress is that which is induced by internal hydrostatic pressure. Accordingly, standards for pressure rated PE pipe require that each material from which a PE pipe is made have an experimentally

established long-term hydrostatic strength (LTHS). The pressure rating of a PE pipe is based on this hydrostatic strength after it has been reduced to a hydrostatic design stress (HDS) by means of a design factor (DF) that gives adequate consideration to the additional nominal and localized stresses that can be generated by other conditions, as well as to the various other factors that can affect reliability and durability under actual service conditions. A discussion of these factors is included in Chapter 5 under the subtopic “Determining a PE’s Appropriate Hydrostatic Design Stress (HDS) Category”.

The methodology for establishing an HDS for PE pipe presumes that at the assigned value of HDS, and also under proper installation, the pipe shall operate in the ductile state. In other words, when it operates at its sustained pressure rating it also has sufficient reserve strength for safely absorbing anticipated add-on stresses, particularly localized stress intensifications. Normal stress increasing situations can result from scratches, gouges, changes in geometry (like those at fittings), rock impingements, etc.

The possible adverse effect by localized stress intensifications on the working strength of engineering materials is well recognized and is addressed by means of these two general strategies:

1. By recognizing a material’s sensitivity to the effect of stress intensifications through
 - a) the application of a larger ‘safety factor’ when establishing a safe design stress; and, or,
 - b) by conducting pipe design not based on the average value of a major stress, but doing so in consideration of the maximum localized stress that may be generated, wherever it is expected to occur – for example, by the application of a special stress concentration factor.^(31, 32)
2. By ensuring that the pipe material has the capacity to operate in the ductile state under the anticipated installation and service conditions. In this case pipe design can proceed on the basis of the nominal (average) value of a major stress.

The latter is the strategy that is employed for qualifying PE materials for piping applications. Because a design that is based on nominal stress presumes a capability for performing in the ductile state, PE piping standards require that the pipe material must not only have an established long-term hydrostatic strength (LTHS), but that it also has to exhibit a very high resistance to the development and growth of slowly growing cracks (SCG), the failure mechanism that may be initiated and then propagated by a localized stress intensification. These are two of three major considerations in the determination of the recommended hydrostatic design stress (HDS) of a PE piping material.

The determination of an HDS needs to also consider the potential effect on working strength by the add-on stresses of very temporary duration – those that result from pressure surges. This leads to a third consideration: The potential adverse effect on working strength by pressure surges.

The methods by which each of these three considerations – long term hydrostatic strength, resistance to slow crack growth and resistance to pressure surges – is evaluated, and the manner in how the results are considered for the establishment of an HDS, is briefly described in the sections that follow.

Establishing a PE's Long-Term Hydrostatic Strength (LTHS) and its Derivative, The Hydrostatic Design Basis (HDB)

It is well recognized that the working strength of materials that exhibit viscoelastic behavior – which includes not just thermoplastics but also other materials such as metals and ceramics at high temperatures – decreases with increased duration of loading^(8, 13). For such materials their long-term working strength for a temperature and other condition of interest is determined based on the result of a sustained-stress versus time-to-rupture (i.e., a stress-rupture) evaluation. The working strength of PE materials is similarly evaluated and a standard protocol has been established for doing so.

The standard basis for determining an LTHS value for PE piping materials is from results of pressure testing in water, or air, for the base temperature of 73°F (23°C). However, many commercial grades of PE materials also have an LTHS that has been determined at an elevated temperature, generally 140°F (60°C). The determination of an LTHS involves three steps, as follows:

1. Circumferential (hoop) stress versus time-to-rupture data are obtained by means of longer-term sustained hydrostatic pressure tests that are conducted on pipe specimens made from the material under evaluation. This testing is performed in accordance with ASTM D1598, Time to Failure of Plastic Pipe Under Constant Internal Pressure⁽⁵⁾. Sufficient stress-rupture data points are obtained for the adequate defining of the material's stress-rupture behavior from about 10hrs to not less than 10,000hrs.
2. The obtained data are then analyzed in accordance with ASTM D2837, Obtaining Hydrostatic Design Basis for Thermoplastic Pipe Materials,⁽⁵⁾ to determine if it constitutes an acceptable basis for forecasting a PE's LTHS. To be acceptable, the data must satisfy the following two requirements:
 - a. A statistical analysis of the stress-rupture data must confirm that a plot of the logarithm of circumferential (hoop) stress versus the logarithm of time-to-fail yields a straight line.

- b. An analysis of separately obtained elevated temperature stress-rupture data that are obtained on the same population of pipe specimens must validate the expectation that the above experimentally established straight line behavior shall continue significantly past the experimental period, through at least 100,000hrs (11.4 years). For the case of materials that are labeled high performance, it must be demonstrated that this straight line behavior shall continue through at least the 50-year intercept. This latter demonstration is labeled substantiation. A description of the validation and substantiation methods appears later in this discussion.
3. When both of the above (2a and 2b) requirements are satisfied this qualifies the mathematical representation of the stress-rupture behavior that is indicated by the experimental data. This mathematical model is then used for forecasting the average stress at which failure will occur at the 100,000hr intercept. The resultant value is labeled the long-term hydrostatic strength (LTHS) of the material under evaluation.

For purposes of simplifying standards that cover pressure rated pipes, an LTHS that is established by the above procedure is next reduced to one of a limited number of standard long-term hydrostatic strength categories, each of which is designated as a Hydrostatic Design Basis (HDB). The hydrostatic design stress (HDS) is then determined by applying an appropriate strength reduction factor – what is termed as the design factor (DF) – to the resultant HDB. The standard convention is to also express the DF in terms of a preferred number. The reduction of an HDB that is stated in terms of a preferred number by means of a DF that is also stated in terms of a preferred number results in an HDS that is always expressed in terms of a preferred number. The interested reader is referred to Chapter 5 for further information on the use of preferred numbers. A detailed description of the standard procedure for the reducing of an LTHS to an HDB, and the subsequent determination of an HDS, is included in Chapter 5, “Standard Specifications, Test Methods and Codes for PE Piping Systems”.

It is important to recognize that because the LTHS is determined at the 100,000hr intercept this does not mean that the intended design life is only for that time period, essentially only about 11 years. This time intercept only represents the standard accepted basis for defining the PE material’s LTHS. The design of a service life for a much longer period is one of the important functions of the DF, based on which an HDB (a categorized LTHS) is reduced to an HDS.

Once the HDS is determined for a particular material the standard pressure rating (PR), or pressure class (PC), for a pipe made from that material may be computed. The Appendix to this Chapter presents the equations that are used for this purpose

as well as a table of the resultant PR's and PC's of pipes that are made to various dimension ratios (DR's).

The results of a stress-rupture evaluation of a PE pipe that has been produced from a high density material are presented in Figure 12. In this evaluation water was present inside and outside the pipe and the testing was conducted at a temperature of 20°C (68°F), and also at two elevated temperatures: 60 and 80°C (140 and 176°F). In this case all of the resultant data have been analyzed by means of a standard mathematical program⁽¹⁴⁾ that also forecasts the long term strength of the PE material at each of these test temperatures. Two forecasts are shown: The higher line is a forecast of the mean value of strength; and, the lower line is a forecast of the lower predictive limit, the LPL. It can be observed that the 80°C data show that a “downturn” occurs after about 2500hrs. At the lower test temperature of 60°C the downturn occurs about a log decade later. By taking into account the effect of temperature on this shift in strength, the mathematical program projects that for the tested material the straight line behavior at 20°C (68°F) shall continue beyond the 50 year intercept, considerably past the minimum 100,000 hours that is imposed by the validation requirement of ASTM D2837.

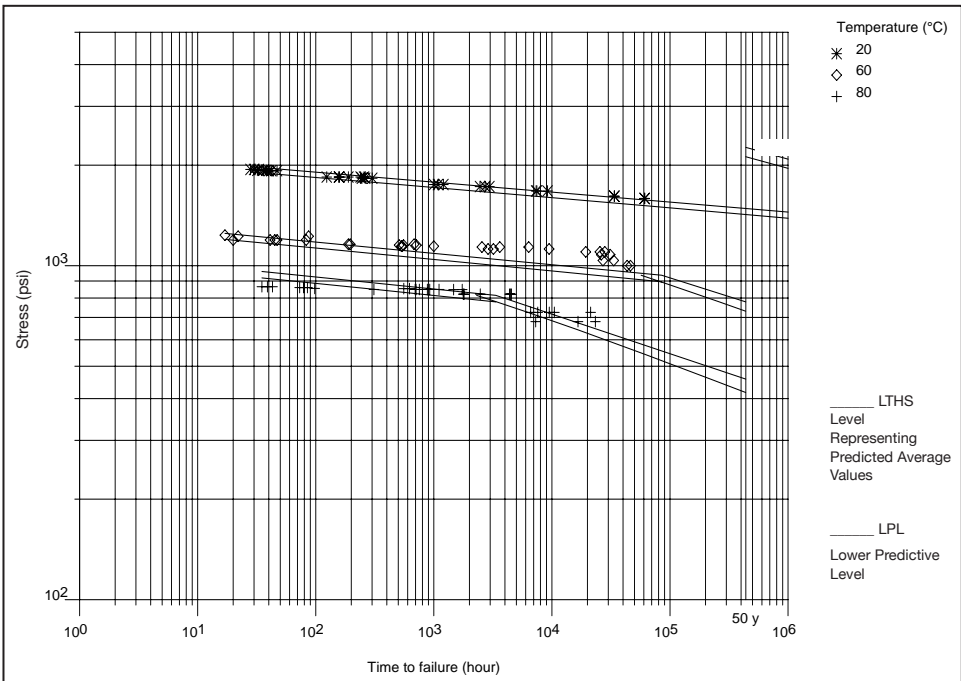

Figure 12 Stress-Rupture Characteristics of an HDPE Pipe Material Similar or Equivalent to PE 4710 (this is not a creep-rupture diagram and the ‘higher performance’ designation refers to the fact that there is no downturn even after 50 years.)

As already stated, a principal objective of the validation requirement is to confirm compliance to the expectation that the straight-line behavior that is exhibited by the experimental data shall continue through at least 100,000hrs. Should this expectation not be realized, then the LTHS as projected by the straight line assumption will be overstated. But, there is another important objective of the validation requirement. It has been determined that the shift to a down turn in the stress-rupture behavior of PE piping materials is the result of a shift in failure mechanism; from ductile to brittle-like. Studies show that brittle-like failures are the end result of a slow crack growth (SCG) mechanism that is initiated by localized stress intensifications that are generated at natural and normal flaws in the pipe material. In the case of PE materials the term flaws refer to very localized and quite normal discontinuities in structure, such as can be caused by gel particles, by residual catalyst, by transitions from crystallites to amorphous material. Materials that display high resistance to inherent flaws are also materials that offer high resistance to localized stress intensifications that are created by external factors. This observation on the effect of inherent flaws on working strength is in line with the behavior of other thermoplastics, as well as that of traditional materials. For example, if it were not for the presence of naturally occurring flaws the working strength of glass would be many times greater. An objective in the development of an engineering material is to minimize its vulnerability to inherent flaws; that is, to enhance its capacity to perform in the ductile state. This is the other important objective of the validation requirement.

A study conducted by the Plastics Pipe Institute⁽¹⁸⁾ has shown that very good quality longer-term field performance is achieved by pipes that are made of PE materials for which the down turn in its ambient temperature stress-rupture behavior is predicted to occur beyond 100,000hrs. Such pipes have been shown to exhibit high resistance to stress increasing situations. In other words, these pipes have a capacity to continually operate in the ductile state. Based on this study, materials for which a downturn is predicted to occur prior to the 100,000hr intercept are excluded from pressure pipe applications. As discussed earlier in this section, it is important to, once again, emphasize that while the LTHS of a PE pipe material is based on its value at 100,000 hours (11.4 years) this does not define its design life.

The newer high performance PE pipe materials – for example the PE4710 materials – exhibit no downturn prior to the 50-year intercept. Because of this, and also because of a couple of additional performance requirements, these newer materials do not require as large a cushion to compensate for add-on stress and therefore, they can safely operate at a higher hydrostatic design stress. A discussion of this matter is included in Chapter 5.

Methodology for the validation of an LTHS

The validation requirement in ASTM D2837 is predicated on the finding that the kinetics of the slow crack growth process is in line with rate process theory^(18, 20, 21, and 27). In accordance with this theory, which has been found to apply to many naturally occurring chemical and mechanical processes, the rate at which a process proceeds is a function of a driving force (e.g., concentration, pressure or stress in the case of a fracture process) and temperature (which affects intensity of molecular activity). The following rate process based equation has been found to well model the experimentally established relationship between a pipe’s time to failure under the SCG process and the magnitude of the applied stress and the temperature.

$$(1) \text{ Log } t = A + B/T + C (\text{log } \delta)/T$$

WHERE

t = time to fail, hrs

T = absolute temperature, °R

δ = circumferential (hoop) stress, psi

A, B, and C = experimentally established coefficients

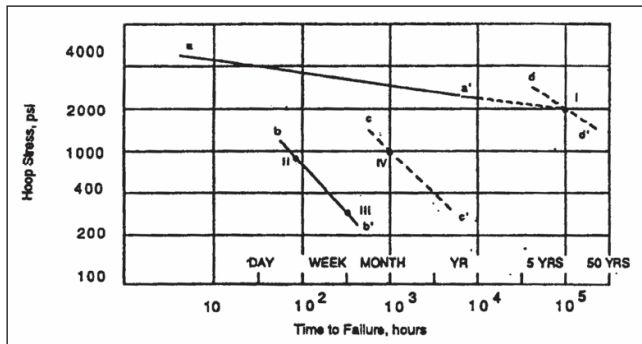

Figure 13 Hoop Stress vs Time to Failure

With reference to Figure 13 the following are the steps that comprise the validation procedure:

1. In accordance with ASTM D2837, evaluate pipe samples of a material of interest at the base temperature of 73.4°F (23°) so as to define the mathematical model that expresses the relationship between hoop stress and time-to-failure (Line a-a’). Then, based on this model compute the predicted value of average hoop stress that results in failure at the 100,000 hour intercept (Point I).
2. At an elevated temperature, but not higher than 194°F (90°C), establish a brittle failure line (line b-b’) by the means of the following procedure:

- a) Using at least six pipe test specimens, subject each specimen to a hoop stress that results in a brittle-like failure (a crack in the pipe wall with no visible sign of deformation) in the range of 100 to 500hrs. The determination of the best stress/temperature combination may require some preliminary trial and error experimentation. Determine the log average of the results (Point II).
- b) Also using not less than six pipe specimens, select a hoop stress that is at least 75psi lower than that used in the above step. Testing under this condition should result in a failure time that ranges from 1,000 to about 2,000hrs. Determine the log average of the results (Point III).
3. Subject at least six pipe samples to the same sustained stress as used under condition 2-a, but conduct the testing at a temperature that is at least 27°F (15°C) lower. Continue this testing until failure of all specimens, or until the log average of the testing times (failures and non-failures) equals or exceeds the time predicted by the requirement that follows (Point IV).
4. To validate that the tested material is in compliance with the D2837 requirement that the straight-line that is depicted by the experimental data shall continue through at least 100,000 hours, the above determined log average failure time (point IV) must at the least equal a value that is predicted by the rate process equation (Equation 1) for which the coefficients A, B and C have been determined based on the experimentally established values of points I, II, and III. PE materials that fail to validate are considered unacceptable for pressure pipe applications.

A challenge in the application of the above method is the high resistance to brittle-like failure that is exhibited by modern PE piping materials. In consequence of this, failure times for these materials at the elevated test temperatures (such as Points III and IV in Figure 13 can be as long as thousands of hours. To achieve a more practical test time an alternate procedure has been established which is based on the Time-Temperature Superposition Principle. This principle is a derivative of the rate process theory. It essentially asserts that a certain stress-rupture performance that is exhibited at an elevated temperature is shifted to a longer time when the temperature is lowered. This shift is exhibited by lines b-b', c-c' and d-d' in Figure 13. Studies show that for PE piping materials of various kinds this shift is adequately represented by means of a common shift factor. Based on this common factor, tables have been established that specify the minimum times to failure at a specified stress and an elevated temperature that ensure the validation of an LTHS for 73.4°F (23°C). These Tables are published in PPI report TR-3.⁽²²⁾

Substantiation: A Step Beyond Validation

Thanks to modern chemistry, PE piping materials have become available which exhibit outstanding resistance to slow crack growth. In consequence of this property

these materials are very highly resistant to brittle-like failure, which results in a straight line stress-rupture behavior at ambient temperature that is predicted to exhibit no downturn prior to the 50-year intercept. This behavior is exhibited by Figure 12. In order to give standard recognition to this very beneficial aspect the substantiation requirement has been established. This requirement is essentially the same as validation, but the difference is that substantiation is the confirmation, also by means of supplementary testing, that the ductile stress-rupture behavior indicated by the experimental data is expected to continue through at least the 50-year intercept.

Compensating for the Effect of Temperature on Working Strength

Many evaluations have been conducted regarding the effect of a sustained temperature on a PE's LTHS. While results show that materials can be affected somewhat differently, they also show that over a range of about 30°F (17°C) above and below the base temperature of 73°F (23°C) the effect is sufficiently similar so that it can be represented by a common set of temperature compensating multipliers. Table A.2 in the Appendix to this chapter lists these common multipliers.

The Appendix also includes guidance for determining a multiplier, for a specific pipe material, for sustained temperatures that are above 100°F (38°C). This determination requires that the PE material from which the pipe is made have a recommended HDB for a temperature above 100°F (38°C), in addition to the universal requirement for pressure pipe applications to have an HDB for the base temperature of 73°F (23°C). This information may be obtained from the pipe supplier or, in the case where the commercial designation of the pipe material is known, it can be obtained by consulting a current copy of PPI Report TR-4. Earlier in this Chapter, the subject of HDB was discussed. For a more thorough discussion of the topic, the interested reader is referred to Chapter 5.

In addition, it is noted in this Appendix that certain standards, codes and manuals that are dedicated to certain applications may list temperature compensating multipliers that are either specific to the PE materials that are covered or, that reflect certain considerations that are unique to the application. For example, in water distribution applications the highest temperature is not sustained all year long. The operating temperature varies with the seasons. Therefore, in AWWA standards and manuals the temperature compensating multipliers apply to a **maximum** operating temperature – as contrasted to a temperature that is sustained – and the values recognize that because of seasonal variations the average operating temperature shall be somewhat below the maximum. Table A.2 in the Appendix presumes that the noted temperature shall be continually sustained. Accordingly, if a standard, code or manual includes a table of temperature de-rating multipliers, those multipliers take precedence over those in Table A.2 in the Appendix.

Compressive Strength

Unlike under the condition of tensile loading, which if excessive can result in a failure, a compressive loading seldom leads to a fracture. Instead, there is a resultant creep in compression, which causes a thickening of the areas resisting the stress, an effect that tends to reduce the true stress. If the stress is excessive failure can occur by yielding (excessive deformation) rather than by a fracture process. For these reasons, it is customary to report compressive strength as the stress required to deform a test sample to a certain strain. Recommended allowable compressive stress values are presented in Table C-1 in the Appendix to this Chapter.

Evaluating the Resistance to Slow Crack Growth (SCG) of a Sharply Notched PE Specimen

As mentioned earlier, a significant value of the validation and the substantiation requirements is that they work to exclude from piping applications those PE materials for which their long-term tensile strength and ductility may be compromised by a lower resistance to the slow crack growth mechanism, as it may be initiated by internal flaws (natural inhomogenities). And, as it was also mentioned earlier, this resistance to the effect of internal flaws is also a recognized index of a PE's resistance to the potentially adverse effect of external flaws. However, indications are that among different kinds of PE's there is not a consistent proportionality between the material's resistance to failure as initiated by internal flaws versus one that is initiated by external flaws. Thus, to more directly determine a PE's resistance to external flaws, ASTM F 1473, "Standard Test Method for Notch Tensile Test to Measure the Resistance to Slow Crack Growth of Polyethylene Pipes and Resins"⁽⁵⁾ was developed. In this method a precisely notched specimen is subjected to a constant load in air that is maintained at a constant temperature of 80°C (176°F). This combination of conditions results in a failure time that can be measured in hours. The failure mechanism is at first, and for the greater part of the failure time, that of a slowly growing crack. When this crack reaches a major size it causes the remaining ligament to be subjected to a sufficiently higher stress such that the final break occurs by a ductile tearing. The total time-to-failure that covers both these mechanisms has been shown to be an index of the quality of a PE's resistance to SCG under actual service conditions.

A study sponsored by the Gas Research Institute (GRI) regarding the quality of long-term field performance of PE pipes versus their time-to-fail under test method ASTM F1473 indicates that 50 hours under this test results in an excellent service life. Or, in other words, this minimum time to failure ensures that under proper installation and operating conditions the pipe shall continue to operate in the ductile state. The lowest ASTM F1473 time to failure for current PE piping materials is 100hrs. This is designated by the numeral 6 in the second digit of the PE pipe material designation

code (e.g., PE 3608). This minimum 100hr value includes a “safety” margin over the GRI determined “safe” value. However, many current materials qualify for the numeral 7 (e.g., PE4710), which designates a time to failure under this test in excess of 500 hours. This performance indicates a superior capacity for safely tolerating localized stress intensifications, which gives added assurance of a pipe’s capability to operate in the ductile state over its intended service life. This is one of the primary requirements that the higher performance PE piping materials must meet in order to qualify for a higher hydrostatic design stress rating. (See Chapter 5 for a discussion on establishing an HDS).

There are materials for which the time-to-fail, when tested under ASTM F1473, is in the thousands of hours. However, it should be kept in mind that under this method, as the time to fail increases, a larger share of this time-to-fail covers the ductile tearing phase, a phase that does not represent resistance to slow crack growth.⁽³⁶⁾ It also should be kept in mind that the objective of setting a minimum time-to-fail requirement is to achieve the beneficial effect of continued operation in the ductile state. Accordingly, when tested under ASTM F1473, a minimum 500 hour time-to-fail requirement has been established for higher performance PE materials, based on information that indicates materials that meet this requirement exhibit maximum efficacy in tempering potential adverse effects that may be caused by localized stress intensifications.

Resistance to Pressure Surges

As discussed earlier, the pressure rating and pressure class of a PE pipe is established based on the material’s long term hydrostatic strength (LTHS), a property that is determined under the condition of a sustained hydrostatic stress. Under actual service conditions pressure surges may occur, which can cause temporary rises in the hydrostatic stress above the sustained working stress. Such rises need to be limited to a value and a total number of occurrences that are safely tolerated by a pipe when it is operating at its working pressure. In the case of some pipe materials, the strength of which is affected by temporary pressure surges, their sustained pressure rating must be appropriately reduced. On the other hand, as evidenced by testing and proven by experience, PE pipe is very tolerant of the effect of pressure surges. Seldom is it necessary to lower a PE pipe’s static pressure rating to compensate for the effect of pressure surges.

Temporary rises in operating pressure may lead to either of these events:

1. The total stress that is induced by the combination of the static plus a surge pressure may reach a magnitude that exceeds the pipe’s hydrostatic strength thereby, causing the pipe to rupture.

2. A large number of surge pressure events coupled with their magnitude may, after some time, result in fatigue of the pipe material so as to cause a sufficient loss of its long-term hydrostatic strength (LTHS) that can lead to a premature failure.

These two events are distinguished by a major difference. The first event is the simple result of an applied stress that exceeds the pipe material's hydrostatic strength. But, the second one is the result of a gradual degradation of this strength by the effects of fatigue. This essential difference is recognized by the two kinds of allowances for sudden pressure surges for PE pipes that are presented in Chapter 6. One of these allowances is for occasional pressure surges, which do not induce fatiguing and, the other covers frequently occurring pressure surges that may result in fatiguing. PE pipe's reaction to each of these two different events is next discussed.

Reaction to Occasional Pressure Surges

PE's viscoelastic nature, which accounts for its decrease in hydrostatic strength with increased duration of loading also results in the opposite effect, an increased strength under decreased duration of loading. Occasional surge pressure events – such as may be caused by a power failure or other malfunction – result in a maximum hydrostatic stress that lasts for only a few seconds, at their longest. However, it should be noted that the short-term hydrostatic strength of PE pipe is more than twice its LTHS.

An evaluation of PE pipe's stress/strain behavior gives further support to its capacity for safely tolerating occasional pressure surges. When a PE pipe is subjected to an add-on stress of very short duration, the resultant additional strain is relatively small, as predicted by the higher apparent modulus that covers this situation (See previous discussion on apparent modulus). And, essentially all of this strain is elastic, meaning that as soon as the surge pressure is gone the added strain is reversed. Because this temporary strain is fully recovered the minimal pipe expansion that occurs during a short lived surge pressure event has no effect on the longer term creep expansion that occurs under the sustained stress that is induced by a steady operating pressure. In other words, surge pressure events of very short term duration have no adverse effect on a PE's long term hydrostatic strength (LTHS).

The above concepts have been confirmed by various studies and they are the basis for the allowances that are presented in Chapter 6.

Reaction to Frequently Occurring Pressure Surges

To a degree that can vary depending on circumstances, the strength of all materials may be adversely affected by fatigue. Modern PE's that meet current requirements for pressure pipe applications have been shown to exhibit very high resistance to fatigue. The primary parameters that affect the degree and the rate at which a material suffers irreversible damage through fatigue are the frequency and totality of the fatigue events as well as the amplitude of the change in stress that occurs under each event.

In PE, the fatigue mechanism that leads to a loss of long-term strength is that of an initial development of microcracks which under the effect of each cycle event slowly grow into larger cracks. It has been shown by various investigators that PE pipe materials which exhibit a very high resistance to slow crack growth under sustained pressure are also materials that exhibit a very high resistance to crack development and growth when subjected to cyclic stressing. In this regard the studies conducted by Bowman⁽⁷⁾ on butt-fused PE piping systems are very informative. They show that even after millions of pressure cycling of substantial magnitude no damage has been detected in the tested systems. And the work by Marshall et al.⁽¹⁷⁾ shows that properly installed pipe made from modern PE piping materials can safely withstand sustained periods of high frequency surging (from 1 to 50 cycles per hour) that result in temporary peak pressure of up to 200 percent of the pipe's static pressure rating with no indication of fatigue and no reduction in long-term serviceability. In a 1999 issue of Water Industry Information and Guidance Note,⁽³⁵⁾ the UK based Water Research Council concludes that for pipes made from high toughness PE materials (e.g., materials offering very high resistance to slow crack growth), fatigue de-rating is generally not required.

The allowances for frequently occurring pressure surges that are presented in Chapter 6 are conservatively based on the results of studies such as those mentioned in the above paragraph.

Other Engineering Properties

Mechanical Properties

Poisson's Ratio – Any stretching or compressing of a test specimen in one direction, due to uniaxial force (below the yield point) produces an adjustment in the dimensions at right angles to the force. A tensile force in the axial direction causes a small contraction in the lateral direction. The ratio of the decrease in lateral strain to the increase in axial strain is called Poisson's ratio (ν).

Poisson's ratio for PE has been found⁽¹⁰⁾ to vary somewhat depending on the ultimate strain that is achieved, on temperature and on the density of the base resin. However, for typical working stresses, strains, and temperatures, an average value of 0.45 is applicable to all PE pipe materials regardless of their densities, and also for both short- and long-term durations of service. This value is also reported in the Appendix attached to this Chapter.

Impact Strength – The concept of impact strength covers at least two important properties:

1. The magnitude of a suddenly applied energy that causes the initiation and propagation of a crack. This is usually assessed by the results of tests on un-notched or, bluntly notched specimens.
2. The magnitude of a suddenly applied energy that causes a crack to rapidly propagate. This is usually assessed by means of very sharply notched specimens.

The results under the first assessment give an indication of a material's susceptibility to brittle fracture absent a source of localized stress concentration. The second assessment gives an indication of whether a material has useful resistance to shattering by the propagation of an existing crack or flaw. A recognized feature of PE materials is their very high resistance to crack initiation under very rapid loading. Consequently, impact tests on this material are always conducted on notched specimens.

The degree of resistance to impact loading depends on many factors that are not assessed by the impact test. They can include mode of impact loading, strain rate, multi-axiality of the stress field, localized stress concentrations, temperature and environment. However, impact test results have been shown to be of very helpful guidance in the selection of materials that can safely resist the potential adverse effects of impact loading. One of the exceptional features of PE pipe is its excellent impact resistance. This has been proven in the gas distribution application for which PE piping has been shown to resist failure by the rapid crack propagation mechanism.

Impact strength is a measure of the energy absorbed during the fracture or ductile deformation of a specimen of standard dimensions and geometry when subjected to a very rapid (impact) loading at a defined test temperature.

There are several types of impact tests that are used today. The most common one in the United States is the notched Izod test, which is illustrated in Figure 14. Notched specimens are tested as cantilever beams. The pendulum arm strikes the specimen and continues to travel in the same direction, but with less energy due to impact with the specimen. This loss of energy is called the Izod impact strength, measured in foot-pounds per inch of notch of beam thickness (ft-lb/in). Compared to other common true thermoplastic piping materials PE offers the highest Izod impact strengths. At ambient temperatures the resultant values exceed 20ft-lbs/in of notch compared to less than 10 for the other materials. And, many types of PE materials do not fail at all under this test.

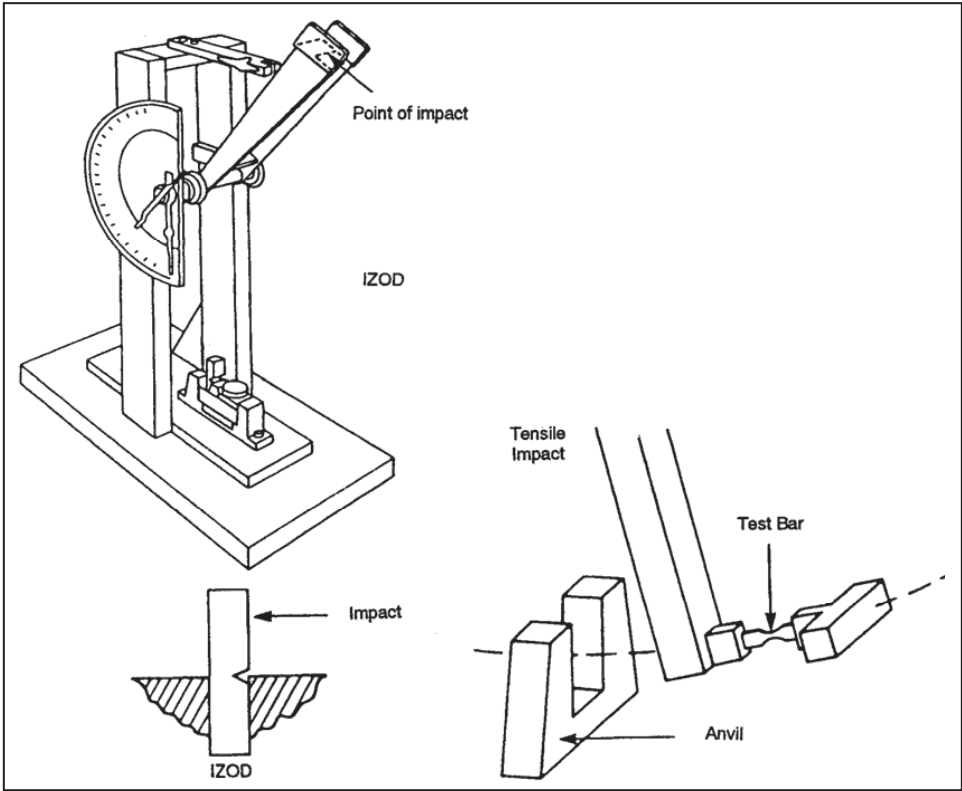

Figure 14 Izod Test

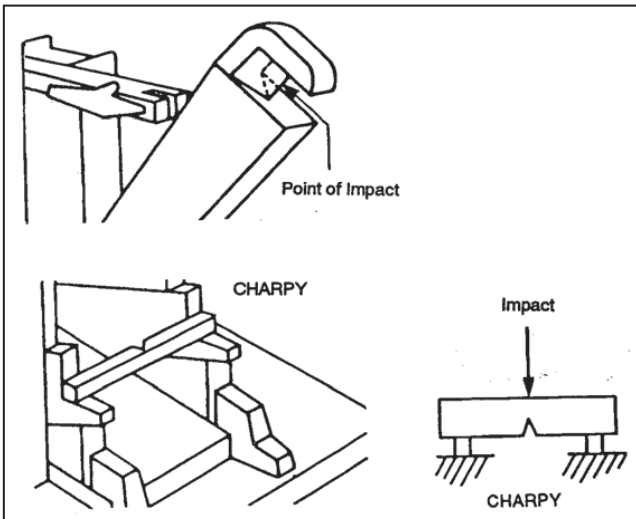

Figure 15 Charpy Test

The Charpy impact test, which is depicted in Figure 15, is widely used in Europe. The specimen is a supported beam, which is then struck with a pendulum. The loss of energy is measured in the same units as in the Izod impact test. At ambient temperature, current PE piping materials also resist failure under this test. ASTM D256, Standard Test Methods for Determining the Izod Pendulum Impact Resistance of Plastics and ASTM D 6110 Standard Test Method for Determining the Charpy Impact Resistance of Notched Specimens of Plastics describe these testing methods.

Resistance to Rapid Crack Propagation

The avoidance of the possibility of the occurrence of a rapid crack propagation (RCP) event in pipe is a very desirable design objective because the consequences of such an event can be very serious, especially when the piping is used for the transport of combustible materials. However, even when transporting an inert material like water an RCP kind of failure can result in a much larger loss of the fluid that is being conveyed as well as in more extensive damage to pipe and fittings. A recognized feature of PE piping is that “it leaks before it breaks”. This feature results from its high ductility and toughness. However, PE’s toughness decreases with decreasing temperature. Other factors that increase the possibility of an RCP event are: the nature of the fluid (compressible versus non-compressible), increasing pipe diameter, increasing wall thickness, and increasing operating pressure. In the case of the conveyance of non-compressible fluids, extensive experience shows that under proper installation and operation of thermally fused PE piping there is very little chance of an RCP event, very much less than with other common thermoplastics piping.

The defining of the exact material requirements and the pipe and operating parameters that will avoid the remote possibility of an RCP event is a complex matter that is still under study⁽¹⁵⁾.

Abrasion Resistance

PE pipe is a frequent choice for the transport of granular or slurry solutions, such as sand, fly ash and coal. The advantage of polyethylene in these applications is its wear resistance, which for example when conveying fine grain slurries has been shown in laboratory tests to be three to five times greater than for steel pipe⁽³⁷⁾. PE pipe has elastic properties that under proper flow conditions allow particles to bounce off its surface. This feature combined with PE’s toughness results in a service life that exceeds that of many metal piping materials.

There are several factors that affect the wear resistance of a pipeline. The concentration, size and shape of the solid materials, along with the pipe diameter and flow velocity, are the major parameters that will affect the life of the pipeline.

The effects of velocity, particle size and solids concentration is discussed in Chapter 6 under the topic of “Pressure Flow of Liquid Slurries”. A report by D. Richards⁽³⁰⁾ covers abrasion resistance factors that apply to dredge pipe applications.

Thermal Properties

Coefficient of Expansion/Contraction

A temperature increase or a decrease can induce a corresponding increase or decrease in the length of a pipe the movement of which is unconstrained. And, in the case of a constrained pipe it can induce the development of a longitudinal tensile or a compressive stress. Both these effects must be given adequate consideration for the proper installation, design and operation of PE piping system. Recommended procedures for dealing with potential reactions that can arise from temperature changes are addressed in various Chapters of this Handbook, but in particular in Chapters 6 (Design of PE Piping Systems), 8 (Above Ground Applications for PE Pipe), and 12 (Horizontal Directional Drilling). These procedures require that two essential properties be adequately defined: the pipe’s linear coefficient of expansion/contraction; and, the pipe material’s apparent modulus.

A property that distinguishes PE pipe from metallic pipe is that its coefficient of thermal expansion is about 10 times larger. This means a larger thermal expansion/contraction in the case of unconstrained pipe. However, another distinguishing feature is a much lower apparent modulus of elasticity. In the case of constrained pipe this leads to a much lower value of thermally induced longitudinal stresses, which greatly simplifies requirements for supporting and anchoring. The aspect of apparent modulus of elasticity has been covered earlier in this Chapter.

ASTM D696, *Standard Test Method for Coefficient of Linear Expansion of Plastics*, is normally used for the determination of this property. The evaluation is usually conducted on injection molded samples. But, it has been determined that the values that are obtained on samples that are machined from extruded pipe are somewhat smaller. And, it also has been noted that the value representing the diametrical expansion/contraction is about 85 to 90% of that which corresponds to the longitudinal expansion/contraction. This difference is attributed to a small anisotropy that results from the manufacturing process. It also has been noted that the value of this property is affected by resin density, an index of crystallinity. Materials made using resins that have a higher crystalline content (i.e., resins of higher density) have somewhat lower values for coefficient of thermal expansion. It has also been observed that within the practical range of normal operating temperatures there is little change in the value of this coefficient.

The resultant values of this property are presented in Table E.1 in the Appendix to this Chapter.

Thermal Conductivity

The capacity of PE materials to conduct heat is only about one hundredth of that of steel or copper. As reported by the values listed in Table E.1 in the Appendix, this capacity increases with resin density (i.e., with increased crystallinity) and it remains fairly constant over the typical range of working temperatures.⁽¹⁰⁾

Specific Heat

Over the range of typical working temperatures, the quantity of heat required to produce a unit temperature rise per unit mass of PE pipe material is about 46% of that for water. And, this capacity is little affected by resin density. In terms of traditional units, and as reported in Table E.1 found in the Appendix, the approximate value of the specific heat of PE piping compositions is 0.46 BTU / lb -°F.

Material Classification Properties

As discussed earlier in this Chapter, commercially available PE piping materials offer a range of properties that are tailored for optimizing certain aspects of engineering performance and ease of processing. For purposes of standardization, an identification system has been established which identifies the available PE piping materials based on important physical properties that can be used to distinguish one kind of PE from another.

This is the major objective of ASTM D3350, Standard Specification for Polyethylene Plastic Pipe and Fittings Material,⁽⁴⁾ a document that is more fully described in Chapter 5. The discussion that follows focuses on a description of the primary properties that are recognized by this ASTM standard. A listing of these properties is included in the Table that follows. Also included in this table is the location in this Handbook in which a brief description of the subject property is presented. As indicated, two of the more important properties – Hydrostatic Strength Classification and Resistance to Slow Crack Growth – have already been described earlier in this Chapter. A brief description of the other properties is presented below.

TABLE 2
Primary Identification Properties for PE Piping Materials in Accordance with ASTM D3350

Property	Test Method	Where Discussed in this Chapter
Density of PE Resin	ASTM D1505, or D792	Under PE Piping Materials and In this Section
Melt Index	ASTM D1238	In this Section
Flexural Modulus	ASTM D790	In this Section
Tensile Strength at Yield	ASTM D638	In this Section
Resistance to Slow Crack Growth	ASTM F1473, or D1693	Under Structural Properties
Hydrostatic Strength Classification	ASTM D2837	Under Structural Properties
Color	Indicated by code letter	In this Section
UV Stabilizer	Indicated by code letter	In this Section

Density

The crystalline content of a PE resin is reflected by its density. As discussed earlier, the crystalline content exerts a major influence on the properties of a PE resin. This is recognized in the Appendix to this Chapter in which certain properties are somewhat different in accordance with the density of the resin that is used in the PE composition. Generally, as crystalline content increases so do stiffness (apparent modulus), tensile strength, and softening temperature. However, for a given kind of molecular structure there is a corresponding decrease in impact strength, and in low temperature toughness.

The accepted technique for obtaining a measure of a PE resin’s crystalline content is to determine its density. A standard method for the measuring of density is ASTM D1505, *Test Method for Density of Plastics by the Density Gradient Technique* ⁽²⁾, or ASTM D792, *Test Methods for Density and Specific Gravity (Relative Density) of Plastics by Displacement* ⁽²⁾.

Melt Index

The melt index is a measure of the flowability of PE materials when in the molten state. This property is an accepted index to two important characteristics of a PE piping material: its processability; and the molecular weight of its primary constituent, the PE resin. A larger melt index denotes a lower melt viscosity, which means the material flows more freely in the molten state. However, a larger melt index also denotes a lower molecular weight, which tends to compromise certain long-term properties. Modern PE’s are tailored so that at a resultant molecular weight and molecular weight distribution they remain quite processible while still offering very good long-term properties. Melt index is also important for joining by heat fusion, more information on which can found in PPI TR-33 and TR-41.

The method by which this property is determined is ASTM D1238, *Standard Test Method for Flow Rates of Thermoplastics by Extrusion Plastometer*⁽²⁾. Under this method the melt index represents the amount of material that passes through a certain size orifice in a given period of time when extruded at a predetermined temperature and under a specified load.

Flexural Modulus

In this test a specimen is supported at both ends and a load is applied in the center at a specified crosshead rate. The flexural modulus is determined at the point when the strain in the outer fiber reaches a value of 2%. The modulus is the ratio of the stress in the outer fiber that results in the 2% strain. It has been determined that the flexural modulus is mainly affected by crystalline content (i.e., resin density) and to a lesser extent by other factors, such as molecular weight and molecular weight distribution, that help to determine size and distribution of crystallites. This property is primarily used for material characterization purposes.

The test method is ASTM D790, *Standard Test Methods for Flexural Properties of Unreinforced and Reinforced Plastics and Electrical Insulating Materials*⁽²⁾. The particular version of this method that is used for PE materials and the conditions at which the testing is conducted is specified in ASTM D3350.

Tensile Strength at Yield

A traditional means for determining the strength of metals and other materials has been the tensile test, by which the stress/strain behavior of the material of interest is evaluated under a constant rate of straining. For most metals a point of interest is that at which yielding occurs – that is, the point at which there is a transition from elastic (reversible) to plastic (non-reversible) stress/strain response. This is because design with elastic materials seeks to ensure that only elastic deformation will result when a stress is applied.

Because of its viscoelastic nature, PE does not exhibit a true elastic region. As illustrated by Figure 16, although PE exhibits a yield point in the tensile test prior to this point the slope of its stress/strain curve decreases with increased strain. And, prior to yielding there is somewhat less than full reversibility in the strain that results from a certain stress. Also, as is illustrated by this Figure the stress strain curve is significantly affected by the rate of straining. Furthermore, the tensile behavior is also significantly affected by temperature. However, the stress at which yielding commences has been determined to be a useful measure for comparing PE piping materials. Because it has been determined that there is no proportionality between tensile strength at yield and long-term strength this property has limited value for design.

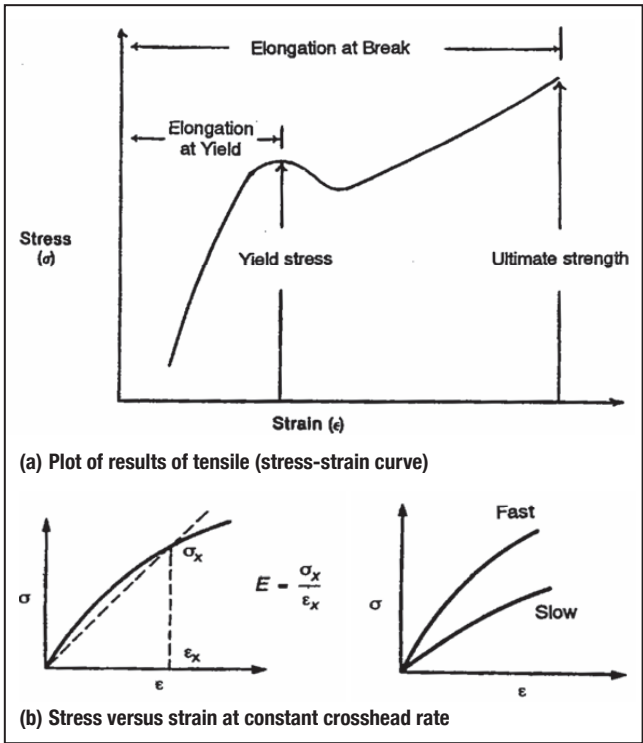

Figure 16 Stress vs Strain Curves Under Specified Conditions

However, it has been also determined that the extent to which a PE deforms in this test prior to failure is an index of the material’s ductility under a sustained loading of very long duration. Accordingly, ASTM D3350 requires that all PE materials that are intended for pressure piping have a minimum extension at break of 500%.

The standard test method for determining a PE’s tensile strength at yield is ASTM D638, *Standard Test Method for Tensile Properties of Plastics*⁽²⁾. To provide a uniform basis for comparing different kinds of PE’s ASTM D638 specifies the sample preparation procedure and it requires that this test be conducted at 23°C (73.4°F) and at a specified strain rate.

Color and UV Stabilization

ASTM D3350 also includes a code denoting the combination of color – natural, or colored, or black – and ultra violet (UV) stabilizer system that is used in the piping material. The specific requirement for a particular color and effectiveness of UV stabilization (e.g., at least six months of outdoor storage; or, for continuous above ground and outdoor use) is usually specified in the applicable pipe product standard.

Electrical Properties

Metals are very good electrical conductors because their atomic and crystalline structure makes available very many free electrons for participation in the conduction process. PE, along with most other polymers, is a poor conductor of electricity because of the unavailability of a large number of free electrons. Being a poor conductor, PE is a very good electrical insulator and is used as such in wiring and in many other electrical applications. Because it very poorly conducts electricity, PE also does not easily dissipate charges resulting from static electricity. Table F.1 in the Appendix to this Chapter lists the typical electrical properties of PE piping materials. In as much as the exact properties of a particular material can vary, interested readers requiring a more accurate representation should consult the pipe and/or pipe material manufacturer.

Static Charge

Since plastics are good insulators, they also tend to accumulate a static charge. PE pipe can acquire a static charge through friction. Sources of friction can be simply the handling of the pipe in during storage, shipping, or installation. Friction can also result from the flow of gas that contains dust or scale or from the pneumatic transport of dry materials. These charges can be a safety hazard if there is a possibility of a combustible leaking gas or of an explosive atmosphere. Such potential hazard should be dealt with prior to working on the pipeline.

A static charge in PE piping will remain in place until a grounding device discharges it. A ground wire will only discharge the static charge from its point of contact. The most effective method to minimize the hazard of a static electricity discharge is to maintain a conductive path to earth ground by applying a film of electrically conductive liquid (for example, water) to the pipe surface work area prior to handling. So that the conductive liquid does not dry out, cloth coverings that are kept moist with the conductive fluid or conductive films may also be wrapped around the pipe. Please refer to the pipe manufacturer for other suggestions.

Chemical Resistance

As indicated earlier in this Chapter, the standard property requirements for PE piping materials are established in an air or a water environment. When considering the use of a PE piping for the transport of another kind of material, the potential reaction by the piping to that material should first be established. This reaction depends on various factors, particularly the chemical or physical effect of the medium on PE, its concentration, the operating temperature, the period of contact and, the operating stress. PE, being a poor conductor of electricity, is immune to electrolytic corrosion such as can be caused by salts, acids and alkalis. However, strong oxidizing agents

can attack the PE molecule directly and lead to a gradual deterioration of properties. Certain organic chemicals can be gradually absorbed by PE, through a process called solvation, causing some swelling, softening and a decrease in long-term strength that largely depends on the chemical configuration of the organic material, but is also affected by other operating variables.

A preliminary measure of the potential effect of a medium on the properties of PE is by means of the so called “soak” or “chemical immersion” test in which the PE is not subjected to any stressing. In this laboratory test, strips of PE material are soaked for different periods of time – generally, not longer than a month – in the medium of interest, which is maintained at a specified temperature. After certain soaking periods, changes are noted in appearance, dimensions, in weight gain or loss, and in strength properties – generally, in tensile strength at yield or elongation at break.

Results obtained by means of an immersion test are a useful guide for applications, such as drainage piping, in which the pipe is subject to only low levels of stressing. However, if the application is a pressurized system, then a more thorough investigation needs to be conducted over and beyond the immersion tests discussed. Please refer to PPI publication TR – 19, Chemical Resistance of Thermoplastics Piping Materials, ⁽²⁶⁾ for more details. In this type of test the immersion period is of limited duration and the effect on strength is only checked by means of a short-term tensile strength test, which is recognized as not a sufficiently reliable indicator of how the tested medium may affect PE’s long-term strength. The standard pressure ratings (PR) and standard pressure classes (PC) that are included in PE pipe standards that are issued by ASTM, AWWA and CSA are for the standard condition of water at 73°F. For the transport of other fluids these PR’s or PC’s may need to be de-rated if the fluid is known to cause a decrease in the pipe material’s long-term strength in consequence of a slowly occurring chemical or physical action. Also, an additional de-rating may be applied in cases where a special consideration is in order – usually, when a greater safety margin is considered prudent because of either the nature of the fluid that is being conveyed or by the possible impact of a failure on public safety. The following is a general representation of the effect of different kinds of fluids on the long-term hydrostatic strength of PE pipe materials and the de-ratings, if any, that are normally applied in recognition of this effect:

- **Aqueous solutions of salts, acids and bases** – Because PE is immune to electrolytic attack these solutions have no adverse effect. Consequently, the PR or PC for water is also appropriate for the conveyance of these type materials.
- **Sewage and wastewater** – Normally, these fluids do not include components that affect PE. Therefore, for this case the PR and PC established for water is also appropriate.

- **Surface active agents (e.g., detergents), alcohols and glycols (including anti-freeze solutions)** – If these agents may be present in the fluid a precautionary measure is to specify PE pipe which is made from a material which exhibits very high resistance to slow crack growth (e.g., materials for which the second number in their standard designation code is either 6 or 7, such as PE2708, PE3608, PE3708, PE3710, PE4608, PE4708 and PE4710). For such materials no de-rating is needed.
- **Fluids containing oxidizing agents** – Strong oxidizers can gradually cause damage to PE material. The rate at which this damage occurs depends on the concentration and the chemical activity of the oxidizing agent. If the rate of damage on unprotected PE is low then PE pipe made from material that is adequately stabilized can be used. But, if the rate is high PE pipe may not be the most appropriate choice. Thus, the determination of the suitability of PE pipe and/or the extent to which it needs to be de-rated should be made on a case-by-case basis. For this purpose it is suggested that the reader contact PPI or its member companies for references regarding the known performance of PE pipes in similar applications.
- **Inert gases such as hydrogen, nitrogen and carbon dioxide** – These kinds of gases have no adverse effect and the PR or PC established for water is also appropriate.
- **Hydrocarbon gases of lower molecular weight, such as methane and hydrogen sulfide** – Studies and long-term experience show that the resultant long-term strength is at least equal to that established when using water or air as a test fluid. Therefore, no de-rating is required.
- **Vapors generated by liquefied petroleum gases (LPG)** – These vapors contain hydrocarbon gases of somewhat greater molecular weight, gases which because of their “plasticizing” or “solvating” effect on PE tend to somewhat reduce PE’s long-term hydrostatic strength. To offset this possible reduction, the PR or PC for water is de-rated by the application of a factor of 0.80 or smaller.
- **Common hydrocarbons in the liquid state, such as those in LPG and fuel gas condensates, in crude oil, in fuel oil, in gasoline, in diesel fuels and in kerosene** – Because exposure to these liquids results in a larger “solvating” effect, the practice is either to de-rate PE pipe to a greater extent than for vapors or, if this de-rating is impractical, to use an alternate material. For crude oil application a de-rating factor of 0.50 is typically used.
- **Aromatic hydrocarbons** – Because aromatic hydrocarbons, such as benzene and toluene, have a much greater “solvating” effect, the use of PE should be avoided.

The above information, taken in conjunction with the results of immersion tests as covered in PPI’s TR-19 chemical resistance document,⁽²⁶⁾ is intended to give general guidance regarding the adequacy of a PE piping system for the transport of a specific medium under a particular set of operating conditions. The most reliable guidance is actual service experience under equivalent or similar conditions. PE

pipng manufacturers, PE material suppliers, and PPI can assist in obtaining this information.

The de-ratings that are mentioned above are only in recognition of the effect of a different fluid than water on the long-term strength of PE pipe. A further de-rating may be called for by a controlling standard or code because of additional considerations, most often for the maximizing of public safety. A designer should comply with the requirements of all applicable codes and standards.

An example of a more conservative de-rating is that by Title 49, Transportation, of the Code of Federal Regulations. The effect of a provision of Part 191 of this code, a part that covers transportation of natural and other fuel gases, is the requirement that the pressure rating of a PE pipe in natural gas service shall be 64% of the pressure rating which would be assigned to that pipe if it conveyed water, provided the water pressure rating is established using an HDS that has been determined based on a design factor (DF) of 0.50. This 64% de-rating is not in response to any adverse effect by natural gas – studies show that similar long-term strengths are obtained when using water or natural gas as the test pressure medium. It is applied mostly in consideration of public safety issues but also in consideration of the minor effect on PE by the small amount of additives that may be contained in fuel gases. There are additional restrictions imposed by this Code, such as the maximum pressure at which a PE pipe may be operated and the acceptable range of operating temperatures.

Another example of a conservative de-rating is that imposed by NFPA / ANSI 58, Standard for the Storage and Handling of Liquefied Petroleum Gases. This standard limits the operating pressure of PE pipe to a maximum of 30psig. The intent of this limitation is to ensure that the LPG gases that are being conveyed are always in the vapor and not in the liquid phase. This is because in the liquid state the constituents of LPG exercise a much more pronounced solvating effect. For further information the reader is referred to PPI publication TR-22, Polyethylene Piping Distribution Systems for Components of Liquid Petroleum Gases.

Permeability

The property of permeability refers to the passage of a substance from one side to the other side of a membrane. Polyethylene has very low permeability to water vapor but it does exhibit some amount of permeability to certain gases and other vapors. As a general rule the larger the vapor molecule or, the more dissimilar in chemical nature to polyethylene, the lower the permeability.

The other factors that affect the rate of permeation include: the difference in concentration, or in the partial pressure of the permeant between the two side of a membrane; the thickness of the membrane (e.g., the wall thickness of a pipe);

temperature; total area available for permeation; and any possible solvating effect by the permeant that can accelerated the rate of permeation.

Depending on the source of a permeant, permeation through a PE pipe can occur from the inside to the outside or, from the outside to the inside. This difference has different potential consequences that need to be recognized and, if significant they also need to be addressed. In the case of possible permeation from the inside the primary concern is the loss of some of the fluid that is flowing through the pipe. Studies show that this is not a problem with liquids. In the case of gases, it has been determined that when conveying methane the loss is so small that there is no problem involving transportation of natural gas. However, as shown in the Table that follows, the permeation rate of hydrogen is several times that of methane. Therefore, if hydrogen is a major constituent of a fuel gas the potential energy loss should be calculated.

The following gases are listed in order of decreasing permeability: sulfur dioxide; carbon dioxide; hydrogen; ethane; oxygen; natural gas; methane; air and nitrogen.

Most of the permeability is through the amorphous regions of the polymer, which is related to density, and to a lesser extent, molecular weight. An increase in density will result in a lower permeability. An increase in molecular weight will also slightly reduce the permeability. Table 3 shows permeation rate of methane and hydrogen through PE as a function of the density of the resin.⁽¹⁾

TABLE 3
Approximate Gas Permeation Rate Through Polyethylene at Ambient Temperature

Piping Material	Permeation Rate, Ft ³ -mil/ft ² -day-atm (The Ft ³ is @ Std. Temp. & Pressure. The Ft ² refers to the outside surface area of the pipe)	
	Methane	Hydrogen
PE2XXX *	4.2x10 ⁻³	21x10 ⁻³
PE3XXX *	2.4x10 ⁻³	16x10 ⁻³
PE4XXX *	1.9x10 ⁻³	14x10 ⁻³

*PE 2XXX, PE3XXX and PE4XXX denotes all PE's that comply, respectively, to the density cell classification 2, or 3, or 4 in accordance with ASTM D3350

In the case of permeation that originates from the outside, most often it is caused by liquids that tend to permeate at much lower rates than gases, which generally do not cause a problem. However, even a low permeation rate – one that results in a “contamination” of only parts per billion – may affect the quality of the fluid that is being conveyed. This possibility is of concern when the pipe, no matter its type, is transporting potable water, and therefore, the issue is addressed by standards that cover this application. However, it is recognized by authorities that any pipe, as well

as an elastomeric gasketed pipe joint, can be subjected to external permeation when the pipeline passes through contaminated soils. Special care should be taken when installing potable water lines through these soils regardless of the pipe material (concrete, clay, plastic, etc.). The Plastics Pipe Institute has issued Statement N – Permeation⁽²⁸⁾ that should be studied for further details.

Properties Related to Durability

Weatherability

All polymers (resins) are susceptible to gradual degradation when continually exposed to ultraviolet (UV) radiation in sunlight.⁽²⁵⁾ There are two effective means for protecting a resin against this effect. One is by the addition of a screen that blocks the penetration of UV rays into the material. The other is by the inclusion of a stabilizer that protects the material by chemical means.

For PE piping materials it has been shown that the most effective screen is achieved by the incorporation into the material of 2 to 3 % of finely divided carbon black, which also results in a black color. Experience and studies show that in outdoor applications such a material will retain its original performance properties for periods longer than 50-years. ASTM D3350, *Standard Specification for Polyethylene Plastic Pipe and Fittings Materials*, recognizes these materials by the inclusion of the code letter C in the material's cell classification.

However, in the case of buried and other kinds of applications in which the pipe shall not be exposed to sunlight indefinitely, the UV protection needs only to cover that time period during which the pipe may be handled and stored outdoors. In practice, this period is about two years. Protection for this period, and somewhat longer, is very effectively achieved by the incorporation into the PE material of a UV stabilizer. An advantage of using a stabilizer is that it allows the pipe to have another color than black. For example, yellow is an accepted color for gas distribution applications, blue for water and green for sewer and drain. The choice of a specific kind of colorant follows an evaluation that is intended to ensure that the chosen colorant does not interfere with the efficiency of the UV stabilizer. Standard ASTM D3350 identifies materials that contain both a UV stabilizer and a colorant by means of the code letter E.

Further information on this subject is presented in PPI Technical Report TR-18, *Weatherability of Thermoplastics Piping*.⁽²⁵⁾

Stabilization

All PE piping materials include stabilizers in order to achieve two principal objectives. The first is to prevent the degradation of the resin during processing and thermal fusion, when melts are subjected to high temperatures. And the second is to protect the pipe during its service life from any deterioration in performance properties that could occur by gradual oxidation.

Exposure of polymers to high temperatures can induce the development of chemical reactions that can adversely affect performance properties. This degradation process results from the formation of free radicals that continue to react with PE, thereby producing a continuing degradation even after the material has been cooled. To prevent the continuation of this process heat stabilizers are added. These stabilizers work by reacting with initial products of degradation so as to form stable species that are incapable of further action.

At lower working temperatures there exists the possibility of a very slowly acting process of oxidative degradation, a process that can cause gradual degradation in performance properties. To counteract against this possibility antioxidants are added to the composition. These antioxidants can protect in a number of ways. A principal one is by deactivating hydroperoxide sites that are formed by oxidation. Most often, two kinds of antioxidants are used because of a synergism effect that substantially enhances the quality of protection.

There are several tests that have been developed which give a reliable guide on the quality of stabilizer and anti-oxidant protection that is included in a PE piping composition. One of these is the thermal stability test that is included in ASTM D3350. In this test a specimen of defined shape and size is heated in an oven, in air, at a predetermined rate of 10°C (18°F) per minute. Eventually, a point is reached at which the temperature rises much more rapidly than the predetermined rate. This point is called the induction temperature because it denotes the start of an exothermic reaction that results from the exhaustion of stabilizer and anti-oxidant protection. The higher the temperature, the more effective the protection. To qualify for a piping application a PE composition is required to exhibit an induction temperature of not less than 220°C (428°F).

Biological Resistance

Biological attack can be described as degradation caused by the action of microorganisms such as bacteria and fungi. Virtually all plastics are resistant to this type of attack. Once installed, polyethylene pipe will not be affected by microorganisms, such as those found in normal sewer and water systems. PE is not a nutrient medium for bacteria, fungi, spores, etc.

Research has shown that rodents and gnawing insects maintain their teeth in good condition by gnawing on objects. Various materials such as wood, copper, lead, and all plastics would fall prey to this phenomenon if installed in rodent-infested areas.

Termites pose no threat to PE pipe. Several studies have been made where PE pipe was exposed to termites. Some slight damage was observed, but this was due to the fact that the plastic was in the way of the termite's traveling pathway. PPI Technical Report TR-11, Resistance of Thermoplastic Piping Materials to Micro- and Macro-Biological Attack⁽²⁴⁾ has further information on this matter.

Properties Related to Health and Safety Concerns

Toxicological

Health Effects

The Food and Drug Administration (FDA) issues requirements for materials that may contact food, either directly or indirectly, under the Code of Federal Regulations (CFR) Title 21, parts 170 to 199. Most natural polyethylene resins do comply with these regulations.

Potable water piping materials, fittings, and pipe are currently tested according to the standards developed by the National Sanitation Foundation (NSF). The most recent standard to be written by the NSF is Standard 61,⁽¹⁹⁾ *Drinking Water System Components – Health Effects*. It sets forth toxicological standards not only for plastics piping but also for all potable water system components. Compliance to these standards is a requirement of most States and/or governing authorities that have jurisdiction over water quality.

There are also other certification programs that are operated by independent laboratory and industrial organizations as well as governmental agencies. These are designed to assure compliance with applicable product standards. Amongst other requirements, these programs may include producer qualification, product testing, unannounced plant inspections and authorized use of compliance labels. Products failing to comply are then de-listed or withdrawn from the marketplace.

Flammability

After continuous contact with a flame, PE will ignite unless it contains a flame retardant stabilizer. Burning drips will continue to burn after the ignition source is removed. The flash ignition and self ignition temperatures of polyethylene are 645°F (341°C) and 660°F (349°C) respectively as determined by using ASTM D1929⁽³⁾, *Standard Test Method for Ignition Properties of Plastics*. The flash point using the Cleveland Open Cup Method, described in ASTM D92⁽⁶⁾, Standard Test method for Flash and Fire Points by Cleveland Open Cup, is 430°F (221°C).⁽⁹⁾

During PE pipe production, some fumes may be generated. If present, they can be an irritant and should be properly vented. Specific information and Material Safety Data Sheets (MSDS) are available from the PE resin manufacturer.

Combustion Toxicity

The combustion of organic materials, such as wood, rubber, and plastics, can release toxic gases. The nature and amount of these gases depends upon the conditions of combustion. For further information on combustion gases, refer to *Combustion Gases of Various Building Materials and Combustion Toxicity Testing from the Vinyl Institute*.^(33,34)

The combustion products of polyethylene differ greatly from those of polyvinyl chloride (PVC). Polyethylene does not give off any corrosive gases such as hydrochloric acid, since it does not contain any chlorine in its polymer structure.

References

1. AGA Plastic Pipe Manual for Gas Service (1985), American Gas Association, Arlington, VA.
2. ASTM Annual Book, Volume 08.01, Plastics (I), C177-D1600, ASTM International, West Conshohocken, PA.
3. ASTM Annual Book, Volume 08.02, Plastics, D1601-D3099, ASTM International, West Conshohocken, PA.
4. ASTM Annual Book, Volume 08.03, Plastics D3100-Latest, ASTM International, West Conshohocken, PA.
5. ASTM Annual Book, Volume 08.04, Plastics Pipe and Building Products, ASTM International, West Conshohocken, PA.
6. ASTM Annual Book, Volume 0-5.01, Petroleum Products and Lubricants, ASTM International, West Conshohocken, PA.
7. Bowman, Jeremy, *The Fatigue Response of Polyvinyl Chloride and Polyethylene Pipe Systems*, Proceedings Plastic Pipes VII, September 1988, Bath, England, The Plastics and Rubber Institute, UK.
8. Dieter, G. E. (1966), *Mechanical Metallurgy*, 3rd Edition, McGraw Hill Book Company, New York, NY.
9. Driscopipe Engineering Characteristics (1981), Phillips Driscopipe, Inc., Richardson, TX.
10. Final Report GRI-99/0192, *Technical Reference for Improved Design and Construction Practices to Account for Thermal Load in Plastic Pipelines*, Gas Research Institute, Chicago, IL.
11. Haag, J., Griffith (1989, January), Measuring Viscoelastic Behavior, *American Laboratory*, No.1, 48-58.
12. Heger, F., R. Chambers, & A. Deitz (1982), *Structural Plastics Design Manual*, American Society of Civil Engineers, New York, NY.
13. Hertzberg, R. W. (1983), *Deformation and Fracture Mechanics of Engineering Materials*, 2nd Edition, J. Wiley & Sons, New York, NY.
14. ISO Standard 9080, Determination of Long-Term Hydrostatic Strength of Thermoplastics Materials in Pipe Form by Extrapolation, International Organization for Standardization.
15. Krishnaswamy, P. et al. (1986), *A Design Procedure and Test Method to Prevent Rapid Crack Propagation in Polyethylene Gas Pipe*, Battelle Columbus Report to the Gas Research Institute, Chicago, IL.
16. Lu X., Zhou Z., & Brown N. (1986), A Small Scale Laboratory Test that Relates to Rapid Crack Propagation in Gas Pipes, Proceedings of the Fourteenth Fuel Gas Pipe Symposium.
17. Marshall, G.P., Brogden, S., *Evaluation of the Surge and /Fatigue resistance of PVC and PE Pipeline Materials for Use in the U.K. Water Industry*, Proceedings Plastic Pipes X, Goteborg, Sweden (Sept., 1998).
18. Mruk, S. A. (1985), *Validating the Hydrostatic Design Basis of PE Piping Materials*, Proceedings of the Ninth Plastics Fuel Gas Pipe Symposium, 202-214.
19. NSF Standard 61, *Drinking Water System Components – Health Effects*, National Sanitation Foundation, Ann Arbor, MI.
20. Palermo, E.F. (1983), *Rate Process Method as a Practical Approach to a Quality Control Method for Polyethylene Pipe*, Proceedings of the Ninth Plastics Fuel Gas Pipe Symposium.
21. Palermo, E.F. & DeBlieu, I.K. (1985), *Rate Process Concepts applied to Hydrostatically Rating Polyethylene Pipe*, Proceedings of the Ninth Plastics Fuel Gas Pipe Symposium.
22. PPI Technical Report TR-3, *Policies and Procedures for Developing Recommended Hydrostatic Design Stresses for Thermoplastic Pipe Materials*, Plastics Pipe Institute, Irving, TX.
23. PPI Technical Report TR-4, *Recommended Hydrostatic Strengths and Design Stresses for Thermoplastics Pipe and Fittings Compounds*, Plastics Pipe Institute, Irving, TX.
24. PPI Technical Report TR-11, *Resistance of Thermoplastic Piping Materials to Micro- and Macro-Biological Attack*, Plastics Pipe Institute, Irving, TX.
25. PPI Technical Report TR-18, *Weatherability of Thermoplastics Piping*, Plastics Pipe Institute, Irving, TX.
26. PPI Technical Report TR-19, *Thermoplastics Piping for the Transport of Chemicals*, Plastics Pipe Institute, Irving, TX.
27. PPI Technical Note TN-16, *Rate Process Method for Evaluating Performance of Polyethylene Pipe*, Plastics Pipe Institute, Irving, TX.

28. PPI Statement N, *Pipe Permeation*, Plastics Pipe Institute, Irving, TX.
29. Powell, P.C., (1983), *Engineering with Polymers*, Chapman and Hall, New York, NY.
30. Richards, D., *Abrasion Resistance of Polyethylene Dredge Pipe*, US Army Engineer Waterways Experiment Station, Hydraulics Laboratory, Vicksburg, MS.
31. Rooke, D.P. & Cartwright, D.J., *Compendium of Stress Intensity Factors*, Her Majesty's Stationery Office, London, UK.
32. Sih, P.K. et al., *Handbook of Stress Intensity Factors for Researchers and Engineers*, Lehigh University, Bethlehem, PA.
33. Vinyl Institute Report on *Combustion Gases of Various Materials* (1987), Vinyl Institute, Washington, DC.
34. Vinyl Institute Report on *Combustion Toxicity Testing* (1986), Vinyl Institute, Washington, DC.
35. Water Industry Information and Guidance Note IGN 4-37-02, *Design Against Surge and Fatigue Conditions for Thermoplastic Pipes* (2006), Water Research Council, Blagrove, Swindon, Wilts, UK
36. Krishnaswamy, Rajendra K., *Analysis of Ductile and Brittle Failures from Creep Rupture Testing of High-Density Polyethylene (HDPE) Pipes*: Plastics Pipes XIII, Washington, DC, October 2-5, 2006.
37. Pankow, Virginia R., *Dredging Applications of High Density Polyethylene Pipe*, Hydraulics Laboratory, U.S. Army Engineer Waterways Experiment Station, Vicksburg, MS 39180-0631, 1987

Appendix A

Pipe Pressure Rating (PR) And Pressure Class (PC)**A.1 - Standard Pipe Pressure Rating (PR) and Standard Pressure Class (PC) for 73°F (23°C)**

Consensus standards for PE pipes intended for pressure applications define PE piping materials in accordance with their recommended hydrostatic design stress (HDS) for water, for the standard base temperature of 73°F (23°C). Most PE pipe standards also identify a pipe's resultant standard pressure rating (PR) or pressure class (PC) for water at 73°F (23°C). As discussed in Chapter 6, this standard PR or PC is determined based on the pipe material's recommended HDS, and the pipe's specified dimension ratio. Pressure ratings for pipes made to common dimension ratios are reproduced in Table A.1 (This is essentially the same Table as Table 6, in Chapter 5).

The pipe's PR or PC may be determined by means of either of the following relationships:

- For pipes made to controlled outside diameters – for which D_o/t is defined as the dimension ratio (DR):

$$PR \text{ or, } PC = \frac{2 (HDS)}{\left[\frac{D_o}{t} - 1 \right]}$$

- For pipes made to controlled inside diameters – for which D_i/t is defined as the inside diameter dimension ratio (IDR):

$$PR \text{ or, } PC = \frac{2 (HDS)}{\left[\frac{D_i}{t} + 1 \right]}$$

WHERE

PR = Pressure Rating, psig (kPa)

PC = Pressure Class, psig (kPa)

HDS = Hydrostatic Design Stress, psi (kPa) = HDB (Hydrostatic Design Basis) x DF (Design Factor).

For more details and discussion of each of these terms and the relationship between them, the reader is referred to Chapters 5 and 6.

D_o = Specified outside pipe diameter, in (mm)

D_i = Specified inside pipe diameter, in (mm)

t = Specified minimum pipe wall thickness, in (mm)

TABLE A.1
Standard Pressure Ratings (PR's) and Standard Pressure Classes (PC's), for Water for 73°F (23°C), for PE Pipes Made to Standard Dimension Ratios

Dimension Ratio (see Note 1)		Standard PR and Standard PC as a Function of the Pipe Material's Recommended Hydrostatic Design Stress (HDS) for Water, at 73°F (23°C)					
DR (Ratio = D_o/t) (Applies to pipes made to controlled outside diameters- D_o)	IDR (Ratio = D_i/t) (Applies to pipes made to controlled inside diameters - D_i)	HDS = 630psi (4.34MPa)		HDS = 800psi (5.52MPa)		HDS = 1000psi (6.90MPa)	
		psig	kPa	Psig	kPa	psig	kPa
32.5	30.5	40	276	50	345	63	434
26.0	24.0	50	345	63	434	80	552
21.0	19.0	63	434	80	552	100	690
17.0	15.0	80	552	100	690	125	862
13.5	11.5	100	690	125	862	160	1103
11.0	9.0	125	862	160	1103	200	1379
9.0	7.0	160	1103	200	1379	250	1724
7.3	5.3	200	1379	250	1724	320	2206

Note 1: While the term, SDR (Standard Dimension Ratio), is an ANSI term, the pipe industry typically uses the term DR as shown in this table.

A.2 – Values for Other Temperatures

As discussed elsewhere in this and the other chapters of this Handbook (See Chapters 5 and 6), the long-term strength properties of PE pipe materials are significantly affected by temperature. In consequence of this, an operating temperature above the base temperature of 73°F (23°C) results in a decrease in a pipe material's HDS and therefore, in a pipe's PR or PC. Conversely, an operating temperature below the base temperature yields the opposite effect. There are three approaches, as follows, for compensating for the effect of temperature:

1. The application of a temperature compensating factor for operating temperatures that range between 40°F (4°C) and 100°F(38°C).

While the effect of temperature on long-term strength is not exactly the same among the different commercially offered PE pipe materials, this effect is sufficiently similar over the temperature range covered by Table A.2 to allow for the establishment of the a common table of Temperature Compensation Multipliers. However, because some dissimilarity, though small, may exist, the reader is advised to consult with the pipe manufacturer to determine the most appropriate multiplier to apply in the particular application under consideration.

TABLE A.2

Temperature Compensating Multipliers for Converting a Base Temperature HDS or PR to HDS or PR for Another Temperature Between 40 and 100°F (4 and 38°C)

Maximum Sustained Temperature, °F (°C) ⁽¹⁾	Multiplier ^(2,3)
40 (4)	1.25
50 (10)	1.17
60 (15)	1.10
73 (23)	1.00
80 (27)	0.94
90 (32)	0.86
100 (38)	0.78

- (1) Temporary and relatively minor increases in temperature beyond a sustained temperature have little effect on the long-term strength of a PE pipe material and thus, can be ignored.
- (2) The multipliers in this table apply to a PE pipe that is made from a material having at least, an established hydrostatic design stress (HDS) for water, for 73°F (23°C). This HDS is designated by the last two numerals in the PE's standard designation code (e.g., the last two digits in PE4710 designate that the HDS for water, for 73°F (23°C), is 1,000psi – See Introduction and Chapter 5 for a more complete explanation.)
- (3) For a temperature of interest that falls within any pair of listed temperatures the reader may apply an interpolation process to determine the appropriate multiplier.

2. In the case of PE pipes that are made from materials that have an established hydrostatic design basis (HDB) for water for both the base temperature of 73°F (23°C) and one higher temperature, the appropriate temperature multiplier for any in-between temperature may be determined by interpolation. Extrapolation above the range bounded by the higher temperature HDB is not recommended.

Prior to the determination of an HDS, PR or PC for a temperature above 100°F (38°C) it should be first determined by contacting the pipe manufacturer that the pipe material is adequate for the intended application.

There are many PE pipe materials for which an HDB has also been established for a higher temperature than the base temperature of 73°F (23°C), generally for 140°F (60°C) and, in a few cases for as high as 180°F (82°C). Information on the elevated temperature HDB rating that is held by the PE material from which a pipe is made can be obtained from the pipe supplier. In addition, PPI issues ambient and elevated temperature HDB recommendations for commercially available PE pipe materials. These recommendations are listed in PPI Technical Report TR-4, a copy of which is available via the PPI web site.

The recognized equation for conducting the interpolation is as follows:

$$F_I = 1 - \frac{HDB_B - HDB_H}{HDB_B} \frac{\frac{1}{T_B} - \frac{1}{T_I}}{\frac{1}{T_B} - \frac{1}{T_H}}$$

WHERE

F_I = Multiplier for the intermediate temperature T_I

HDB_B = Hydrostatic Design Basis (HDB) for the base temperature (normally, 73°F or 23°C), psi

HDB_H = Hydrostatic Design Basis (HDB) for the higher temperature, psi

T_B = Temperature at which the HDB_B has been determined, °Rankin (°F + 460)

T_H = Temperature at which the HDB_H has been determined, °Rankin (°F + 460)

T_I = Intermediate temperature, °R (°F + 460)

Examples of the application of this equation are presented at the end of this Section.

- By regulation. There are certain codes, standards and manuals that cover certain applications (e.g., AWWA water applications and gas distribution piping) that either list temperature compensating multipliers for approved products or, which define rules for their determination. For applications that are regulated by these documents their particular requirements take precedence. For example, AWWA standards C 901 and C 906 and manual M 55 which cover PE pressure class (PC) pipe include an abbreviated table of temperature compensation multipliers that differ slightly from what is presented here. The multipliers in the AWWA tables apply to temperature ranges typical for water applications and are rounded to a single decimal. The interested reader is advised to refer to these documents for more details.

Examples of the Application of the Interpolation Equation

Example – A PE pipe is made from a PE4710 material that has an established HDB of 1600psi for 73°F (533°R) and, an HDB of 1,000psi for 140°F (600°R). What is the temperature compensating multiplier for a sustained operating temperature of 120°F (580°R)?

$$\text{For this case, } F_{120^\circ\text{F}} = 1 - \frac{(1600 - 1000)}{1600} \left[\frac{\frac{1}{533} - \frac{1}{580}}{\frac{1}{533} - \frac{1}{600}} \right] = 0.73$$

Appendix B

Apparent Elastic Modulus

B.1 – Apparent Elastic Modulus for the Condition of Either a Sustained Constant Load or a Sustained Constant Deformation

B.1.1 – Design Values for the Base Temperature of 73°F (23°C)

TABLE B.1.1
Apparent Elastic Modulus for 73°F (23°C)

Duration of Sustained Loading	Design Values For 73°F (23°C) ^(1,2,3)					
	PE 2XXX		PE3XXX		PE4XXX	
	psi	MPa	psi	MPa	psi	MPa
0.5hr	62,000	428	78,000	538	82,000	565
1hr	59,000	407	74,000	510	78,000	538
2hr	57,000	393	71,000	490	74,000	510
10hr	50,000	345	62,000	428	65,000	448
12hr	48,000	331	60,000	414	63,000	434
24hr	46,000	317	57,000	393	60,000	414
100hr	42,000	290	52,000	359	55,000	379
1,000hr	35,000	241	44,000	303	46,000	317
1 year	30,000	207	38,000	262	40,000	276
10 years	26,000	179	32,000	221	34,000	234
50 years	22,000	152	28,000	193	29,000	200
100 years	21,000	145	27,000	186	28,000	193

- (1) Although there are various factors that determine the exact apparent modulus response of a PE, a major factor is its ratio of crystalline to amorphous content – a parameter that is reflected by a PE's density. Hence, the major headings PE2XXX, PE3XXX and, PE4XXX, which are based on PE's Standard Designation Code. The first numeral of this code denotes the PE's density category in accordance with ASTM D3350 (An explanation of this code is presented in Chapter 5).
- (2) The values in this table are applicable to both the condition of sustained and constant loading (under which the resultant strain increases with increased duration of loading) and that of constant strain (under which an initially generated stress gradually relaxes with increased time).
- (3) The design values in this table are based on results obtained under uni-axial loading, such as occurs in a test bar that is being subjected to a pulling load. When a PE is subjected to multi-axial stressing its strain response is inhibited, which results in a somewhat higher apparent modulus. For example, the apparent modulus of a PE pipe that is subjected to internal hydrostatic pressure – a condition that induces bi-axial stressing – is about 25% greater than that reported by this table. Thus, the Uni-axial condition represents a conservative estimate of the value that is achieved in most applications.

It should also be kept in mind that these values are for the condition of continually sustained loading. If there is an interruption or a decrease in the loading this, effectively, results in a somewhat larger modulus.

In addition, the values in this table apply to a stress intensity ranging up to about 400psi, a value that is seldom exceeded under normal service conditions.

B.1.2 – Values for Other Temperatures

The multipliers listed in Table B.1.2 when applied to the base temperature value (Table B.1.1) yield the value for another temperature.

TABLE B.1.2
Temperature Compensating Multipliers for Determination of the
Apparent Modulus of Elasticity at Temperatures Other than at 73°F (23°C)
Equally Applicable to All Stress-Rated PE's
(e.g., All PE2xxx's, All PE3xxx's and All PE4xxx's)

Maximum Sustained Temperature of the Pipe °F (°C)	Compensating Multiplier
-20 (-29)	2.54
-10 (-23)	2.36
0 (-18)	2.18
10 (-12)	2.00
20 (-7)	1.81
30 (-1)	1.65
40 (4)	1.49
50 (10)	1.32
60 (16)	1.18
73.4 (23)	1.00
80 (27)	0.93
90 (32)	0.82
100 (38)	0.73
110 (43)	0.64
120 (49)	0.58
130 (54)	0.50
140 (60)	0.43

B.2 – Approximate Values for the Condition of a Rapidly Increasing Stress OR Strain

B.2.1 – Values for the Base Temperature of 73°F (23°C)

TABLE B.2.1

Rate of Increasing Stress	Approximate Values of Apparent Modulus for 73°F (23°C)					
	For Materials Coded PE2XXX ⁽¹⁾		For Materials Coded PE3XXX ⁽¹⁾		For Materials Coded PE4XXX ⁽¹⁾	
	psi	MPa	psi	MPa	psi	MPa
“Short term” (Results Obtained Under Tensile Testing) ⁽²⁾	100,000	690	125,000	862	130,000	896
“Dynamic” ⁽³⁾	150,000psi (1,034MPa), For All Designation Codes					

- (1) See Chapter 5 for an explanation of the PE Pipe Material Designation Code. The X's designate any numeral that is recognized under this code.
- (2) Under ASTM D638, “Standard Test Method for Tensile Properties of Plastics”, a dog-bone shaped specimen is subjected to a constant rate of pull. The “apparent modulus” under this method is the ratio of stress to strain that is achieved at a certain defined strain. This apparent modulus is of limited value for engineering design.
- (3) The dynamic modulus is the ratio of stress to strain that occurs under instantaneous rate of increasing stress, such as can occur in a water-hammer reaction in a pipeline. This modulus is used as a parameter for the computing of a localized surge pressure that results from a water hammer event.

B.2.2 – Values for Other Temperatures

The values for other temperatures may be determined by applying a multiplier, as follows, to the base temperature value:

- For Short-Term Apparent Modulus – Apply the multipliers in Table B.1.2
- For Dynamic Apparent Modulus – Apply the multipliers in Table B.2.2

TABLE B.2.2

Dynamic Modulus, Temperature Compensating Multipliers

Temperature , °F (°C)	Multiplier
40 (4)	1.78
50 (10)	1.52
60 (16)	1.28
73.4 (23)	1.00
80 (27)	0.86
90 (32)	0.69
100 (38)	0.53
110 (43)	0.40
120 (49)	0.29

Appendix C

Allowable Compressive Stress

Table C.1 lists allowable compressive stress values for 73°F (23°C). Values for allowable compressive stress for other temperatures may be determined by application of the same multipliers that are used for pipe pressure rating (See Table A.2).

TABLE C.1
Allowable Compressive Stress for 73°F (23°C)

	Pe Pipe Material Designation Code ⁽¹⁾					
	PE 2406		PE3408		PE 4710	
	PE 2708		PE 3608			
			PE 3708			
			PE 3710			
			PE 4708			
	psi	MPa	psi	MPa	psi	MPa
Allowable Compressive Stress	800	5.52	1000	6.90	1150	7.93

(1) See Chapter 5 for an explanation of the PE Pipe Material Designation Code.

Appendix D

Poisson's Ratio

Poisson's Ratio for ambient temperature for all PE pipe materials is approximately 0.45.

This 0.45 value applies both to the condition of tension and compression. While this value increases with temperature, and vice versa, the effect is relatively small over the range of typical working temperatures.

Appendix E Thermal Properties

TABLE E.1
Approximate Value of Thermal Property for Temperature Range Between 32 and 120°F (0 and 49°C)

Thermal Property	PE Pipe Material Designation Code ⁽¹⁾		
	PE2XXX	PE3XXX	PE4XXX
Coefficient of Thermal Expansion/Contraction ⁽²⁾ (in/in · °F)	10 × 10 ⁻⁵	9.0 × 10 ⁻⁵	8.0 × 10 ⁻⁵
Specific Heat BTU / LB - °F	0.46		
Thermal Conductivity (BTU · in /hr · sq. ft · °F)	2.6	3.0	3.1

- (1) See Chapter 5 for an explanation of the PE Pipe Material Designation Code. The X's designate any numeral that is recognized under this code.
- (2) The thermal expansion coefficients define the approximate value of the longitudinal (axial) expansion/contraction that occurs in PE pipe. Because of a certain anisotropy that results from the extrusion process the diametrical expansion is generally lesser, resulting in a diametrical expansion/contraction coefficient that is about 85 to 90% of the axial value.

Appendix F Electrical Properties

Table F.1 lists the approximate range of values of electrical properties for ambient temperatures for all commercially available PE pipe materials. The actual value for a particular PE piping material may differ somewhat in consequence, mostly, of the nature and quantity of additives that are included in the formulation. For example, formulations containing small quantities of carbon black – an electrical conductor – may exhibit slightly lower values than those shown in this table.

TABLE F.1
Approximate Range of Electrical Property Values for PE Piping Materials

Electrical Property	Test Method	Range of Property Value	
		Range	Unit
Volume Resistivity	–	>10 ¹⁶	Ohms-cm
Surface Resistivity	–	>10 ¹³	Ohms
Arc Resistance	ASTM D495	200 to 250	Seconds
Dielectric Strength	ASTM D149 (1/8 in thick)	450 to 1,000	Volts/mil
Dielectric Constant	ASTM D150 (60Hz)	2.25 to 2.35	–
Dissipation Factor	ASTM D150 (60Hz)	>0.0005	–